

Operating Instructions
Original Operating Instructions

Cubis®

MCE Models
Precision Balances



1000047954



SARTORIUS

Contents

1	About these Instructions	5	5	Installation	26
1.1	Scope.....	5	5.1	Scope of Delivery.....	26
1.2	Symbols Used.....	5	5.2	Selecting an Installation Site.....	26
1.2.1	Warnings in Operating Instructions ..	5	5.3	Unpacking the Device.....	27
1.2.2	Other Symbols.....	5	5.4	Removing the Control Unit.....	27
1.3	Target Groups.....	6	5.5	Preparing Below-cell Weighing.....	28
2	Safety Instructions	7	5.6	Positioning the Weighing Pan and Associated Components.....	29
2.1	Intended Use.....	7	5.7	Acclimatization.....	30
2.1.1	Modifications to the Device.....	7	6	Getting Started	31
2.1.2	Repairs to the Device.....	7	6.1	Connecting Electronic Components.....	31
2.2	Personnel Qualification.....	8	6.2	Installing the AC Adapter.....	31
2.3	Significance of these Instructions.....	8	6.3	Connecting the Power Supply.....	32
2.4	Functionality of the Device.....	8	6.4	Attaching the Protective Caps.....	32
2.5	Safety Information on the Device.....	8	7	System Settings	33
2.6	Electrical Equipment.....	9	7.1	Performing System Settings.....	33
2.6.1	Damage to the Electrical Equipment of the Device.....	9	7.2	Switching Off the isoCAL Function.....	33
2.6.2	Working on the Device's Electrical Equipment.....	9	7.3	Parameter List.....	34
2.6.3	AC Adapter and Power Supply Cable..	9	7.3.1	Parameters in the "Setup" Main Menu.....	34
2.7	Conduct in an Emergency.....	9	7.3.2	Parameters in the "Device" Main Menu.....	37
2.8	Accessories, Consumables, and Spare Parts...	9	7.3.3	Parameters in the "Data Output" Main Menu.....	40
2.9	Personal Protective Equipment.....	10	7.3.4	Parameters in the "Applications" Main Menu.....	42
2.10	Glass Breakage.....	10	7.3.5	Parameters in the "Input" Main Menu.....	45
3	Device Description	11	7.3.6	Parameters in the "Language" Main Menu.....	45
3.1	Device Overview.....	11	7.3.7	Parameters in the "Unit 1", "Unit 2", "Unit 3", and "Unit 4" Function Menus.....	46
3.2	Weighing Pan and Associated Components..	12	8	Operation	47
3.3	Connections and Components on the Weighing Module.....	12	8.1	Switching the Device On and Off.....	47
3.4	Connections on the Control Unit.....	13	8.2	Leveling the Device.....	47
3.5	Safety Equipment.....	13	8.2.1	Leveling the Device with the Level ..	47
3.5.1	Protective Caps on the Weighing Module.....	13	8.2.2	Leveling a Device with Manual Feet with Inclination Sensor.....	48
3.6	Conformity-assessed Devices.....	14	8.2.3	Leveling a Device with Motorized Feet.....	49
3.7	Symbols on the Device.....	14	8.3	Preparing Weighings.....	49
4	Operating Concept	15	8.4	Weighing.....	49
4.1	Operating Display in Weighing Mode.....	15	8.5	Overview of Calibration, and Adjustment...	50
4.2	Operating Display in the Menu.....	16	8.6	Adjusting with the isoCAL Function.....	50
4.3	Buttons and Keys on the Operating Display ..	16	8.7	Internally Calibrating and Adjusting the Device.....	51
4.4	Displays in the Operating Display.....	18			
4.5	Menu Structure.....	19			
4.5.1	Overview of the Device Settings Menu.....	19			
4.6	Navigating the Menus.....	24			

8.8	Externally Calibrating and Adjusting the Device (Not for Conformity-assessed Models).....	52	15.3	Ambient Conditions	68
8.9	Printing Results	54	15.3.1	Installation Site	68
8.10	Weighing and Printing with ID Marking.....	54	15.3.2	Ambient Temperature for the isoCAL Function.....	69
8.11	Running Applications (Examples)	55	15.3.3	Protection Class	69
8.11.1	Executing the “Toggle Between Weight Units” Function.....	55	15.4	Materials.....	70
8.11.2	Running the “Statistics” Application .	56	15.5	Integrated Clock.....	70
9	Cleaning and Maintenance	58	15.6	Backup Battery	70
9.1	Preparing the Device	58	15.7	Metrological Data.....	71
9.2	Cleaning the Device	58	15.7.1	Models MCE14202S MCE14202P MCE10202S MCE8202S.....	71
9.3	Assembling and Connecting the Device.....	59	15.7.2	Models MCE6202S MCE6202P MCE4202S MCE2202S.....	72
9.4	Maintenance Schedule	59	15.7.3	Models MCE1202S MCE12201S MCE8201S MCE5201S.....	73
9.5	Performing a Software Update	59	15.8	Recommended Calibration Weight.....	74
10	Malfunctions	60	15.9	isoCAL Function	74
10.1	Status Messages	60	15.9.1	Models MCE14202S MCE14202P MCE10202S.....	74
10.2	Warning Messages	60	15.9.2	Models MCE8202S MCE6202S MCE6202P MCE4202S MCE2202S MCE1202S	74
10.3	Troubleshooting	62	15.9.3	Models MCE12201S MCE8201S MCE5201S	75
11	Decommissioning	64	15.10	Interfaces	75
11.1	Decommissioning the Device.....	64	15.10.1	Specifications for the COM-RS232 Interface	75
12	Transport.....	64	15.10.2	Specifications for the USB-A Interface	75
12.1	Transporting the Device	64	15.10.3	Specifications for the USB-B Interface	75
13	Storage and Shipping	65	16	Accessories	76
13.1	Storage	65	16.1	Accessories	76
13.2	Returning Device and Parts.....	65	16.1.1	Printers and Communication	76
14	Disposal.....	66	16.1.2	Displays and Input Output Elements	76
14.1	Information on Decontamination.....	66	16.1.3	Weighing Tables.....	77
14.2	Dispose of Device and Parts	66	16.1.4	Weighing Accessories	77
14.2.1	Information on Disposal	66	17	Sartorius Service	78
14.2.2	Disposal	66	18	Conformity Documents.....	78
15	Technical Data	67			
15.1	Dimensions and Weight	67			
15.1.1	Precision Balance.....	67			
15.2	Power Supply	67			
15.2.1	Device	67			
15.2.2	Power Supply Unit.....	67			
15.2.3	Safety of Electrical Equipment	68			
15.2.4	Electromagnetic Compatibility	68			

1 About these Instructions

1.1 Scope

These instructions are part of the device. These instructions apply to the device in the following versions:

Device	Model
Cubis® precision balance	MCE10202S-... MCE1202S-... MCE12201S-... MCE14202P-... MCE14202S-... MCE2202S-... MCE4202S-... MCE5201S-... MCE6202P-... MCE6202S-... MCE8201S-... MCE8202S-...

1.2 Symbols Used

1.2.1 Warnings in Operating Instructions

WARNING

Denotes a danger with the risk that death or severe injury may result if it is **not** avoided.



CAUTION

Denotes a hazard that may result in moderate or minor injury if it is **not** avoided.

NOTICE

Denotes a danger with the risk that property damage may result if it is **not** avoided.

1.2.2 Other Symbols

-  Required action: Describes actions which must be carried out.
-  Result: Describes the result of the actions carried out.
- [] Text inside brackets refers to control and display items.
- [] Text inside brackets indicates status, warning, and error messages.
-  Indicates information for legal metrology for conformity-assessed (verified) devices. Conformity-assessed devices are also referred to as “verified” in these instructions.

Figures on the Operating Display

The figures on the operating display of the device may deviate from those in these instructions.

1.3 Target Groups

These instructions are addressed to the following target groups. The target groups must possess the specified knowledge.

Target group	Knowledge and responsibilities
User	<p>The user is familiar with the operation of the device and the associated work processes. They understand the hazards which may arise when working with the device and know how to prevent them.</p> <p>They have been trained in the operation of the device. The training is carried out by the operating engineer laboratory manager or the operator of the device.</p>
Operator	<p>The operator of the device is responsible for compliance with safety requirements and workplace safety regulations.</p> <p>The operator must ensure that all persons who work with the device have access to the relevant information and are trained in working with the device.</p>

2 Safety Instructions

2.1 Intended Use

The device is a high-resolution balance, which can be used in laboratories. The device was developed for the accurate determination of the mass of materials in liquid, paste, powder, or solid form.

Appropriate containers must be used for loading each type of material. The device can be used in stand-alone operation or can be operated on a PC.

The device is exclusively designed for use according to these instructions. Any further use beyond this is considered **improper**.

If the device is **not** used properly: The protective systems of the device may be impaired. This can lead to unforeseeable personal injury or property damage.

Operating Conditions for the Device

Do **not** use the device in potentially explosive environments. The device may only be used indoors.

The device may only be used with the equipment and under the operating conditions described in the Technical Data section of these instructions.

2.1.1 Modifications to the Device

If the device is modified, for example by attaching extra components, device safety may be affected, or the device may cease to be compliant.

If you have any queries regarding modifications to the device, contact Sartorius.

2.1.2 Repairs to the Device

Device repairs may only be carried out by persons with appropriate specialized knowledge of the device. If the device is **not** repaired by a specialist, the safety of the device may be impaired or the quality marks may lose their validity.

We recommend that any repair work, even that not covered by the warranty, is carried out by Sartorius Service or after consulting with Sartorius Service.

2.2 Personnel Qualification

If people who do **not** have sufficient knowledge on the safe handling of the device carry out work on the device, those people may injure themselves or other people nearby.

- ▶ Ensure that all individuals working on the device possess the necessary knowledge and qualifications (see Chapter “1.3 Target Groups”, page 6).
- ▶ If a particular qualification is required for the actions described: Have these activities carried out by the required target group.
- ▶ If **no** qualification is required for the actions described: Have these activities carried out by the “user” target group.

2.3 Significance of these Instructions

Failure to follow the instructions in this manual can have serious consequences, e.g., exposure of individuals to electrical, mechanical, or chemical hazards.

- ▶ Before working with the device: Read the instructions carefully and completely.
- ▶ If these instructions are lost: Request a replacement or download the latest version from the Sartorius website (www.sartorius.com).
- ▶ Ensure that the information contained in these instructions is available to all individuals working on the device.

2.4 Functionality of the Device

A damaged device or worn parts may lead to malfunctions or cause hazards which are difficult to recognize.

- ▶ Only operate the device when it is safe and in perfect working order.
- ▶ Have any malfunctions or damage repaired immediately by Sartorius Service.

2.5 Safety Information on the Device

Symbols, e.g. warnings and safety stickers, are safety information for the handling of the device. Missing safety information may lead to serious injuries.

- ▶ Do **not** conceal, remove, or modify the symbols.
- ▶ Replace the symbols if they become illegible.

2.6 Electrical Equipment

2.6.1 Damage to the Electrical Equipment of the Device

Damage to the electrical equipment of the device, e.g. damage to the insulation, can be life-threatening. Contact with parts under voltage represents a direct danger to life.

- ▶ If the device's electrical equipment is defective, disconnect the device from the power supply and contact Sartorius Service.
- ▶ Keep live parts away from moisture. Moisture can cause short circuits.

2.6.2 Working on the Device's Electrical Equipment

Only Sartorius Service personnel may work on or modify the electrical equipment of the device. The device may only be opened by Sartorius Service personnel.

2.6.3 AC Adapter and Power Supply Cable

Serious injury can result, e.g. from electric shocks, if an unsuitable and inadequately dimensioned power supply cable or unsuitable power supply is used.

- ▶ Only use the original power supply cable and power supply.
- ▶ If the power supply or power supply cable must be replaced: Contact Sartorius Service. Do **not** repair or modify the power supply or power supply cable.

2.7 Conduct in an Emergency

If there is immediate danger of personal injury or if there is a risk of damage to the device, e.g., due to malfunctions or dangerous situations, the device must be immediately taken out of operation.

- ▶ Disconnect the device from the power supply cable by disconnecting the power supply cable.
- ▶ Malfunctions should be remedied by Sartorius Service.

2.8 Accessories, Consumables, and Spare Parts

The use of unsuitable accessories, consumables, and spare parts can affect the functionality and safety of the device and have the following consequences:

- Risk of injury to persons
 - Damage to the device
 - Malfunction of the device
 - Device failure
- ▶ Only use approved accessories, and spare parts supplied by Sartorius.
 - ▶ Only use accessories, consumables, and spare parts that are in proper working order.

2.9 Personal Protective Equipment

Personal protective equipment protects against risks arising from the materials being processed. Missing or unsuitable personal protective equipment can result in injuries.

- ▶ If the workplace or process in which the device is being used requires personal protective equipment: Wear personal protective equipment.

2.10 Glass Breakage

Glass components can break if they fall or are handled incorrectly. Glass fragments can cause cuts.

- ▶ Only lift the device by its base, **not** by the draft shield.
- ▶ When lifting and transporting, ensure that **no** personnel or objects are in the way.
- ▶ Only operate the operating display with your fingers. Do **not** use pointed or sharp objects.

3 Device Description

3.1 Device Overview

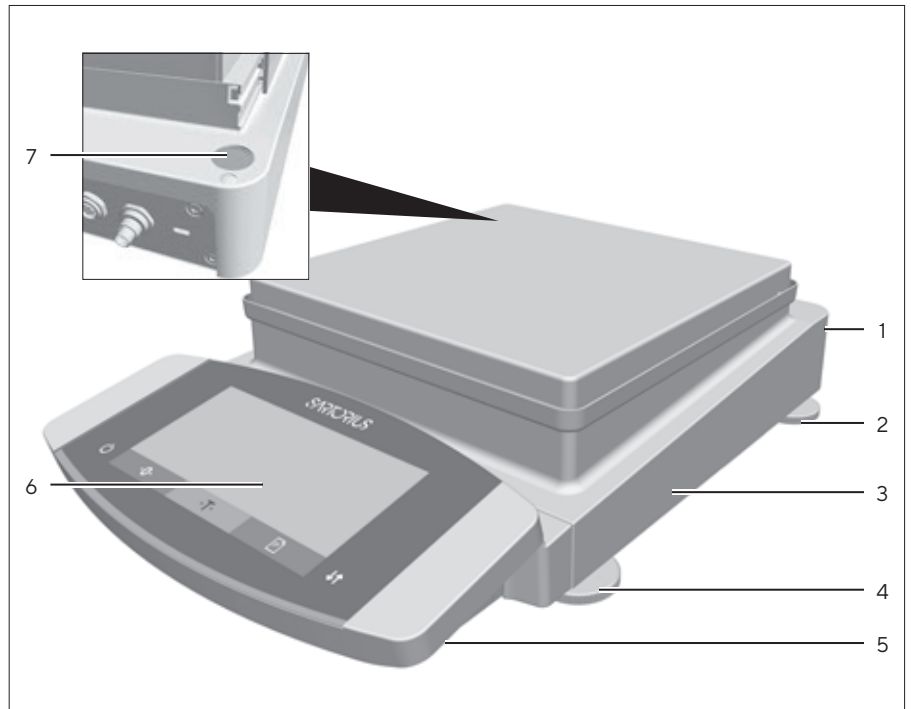

Fig. 1: Precision balance (example)

Pos.	Name	Description
1	Manufacturer's ID label	Not depicted
2	Leveling foot	Depending on the model: Not adjustable, is screwed in for leveling.
3	Weighing module	
4	Leveling foot	Motorically or manually adjustable
5	Control unit	
6	Operating display	Touchscreen
7	Level	

3.2 Weighing Pan and Associated Components

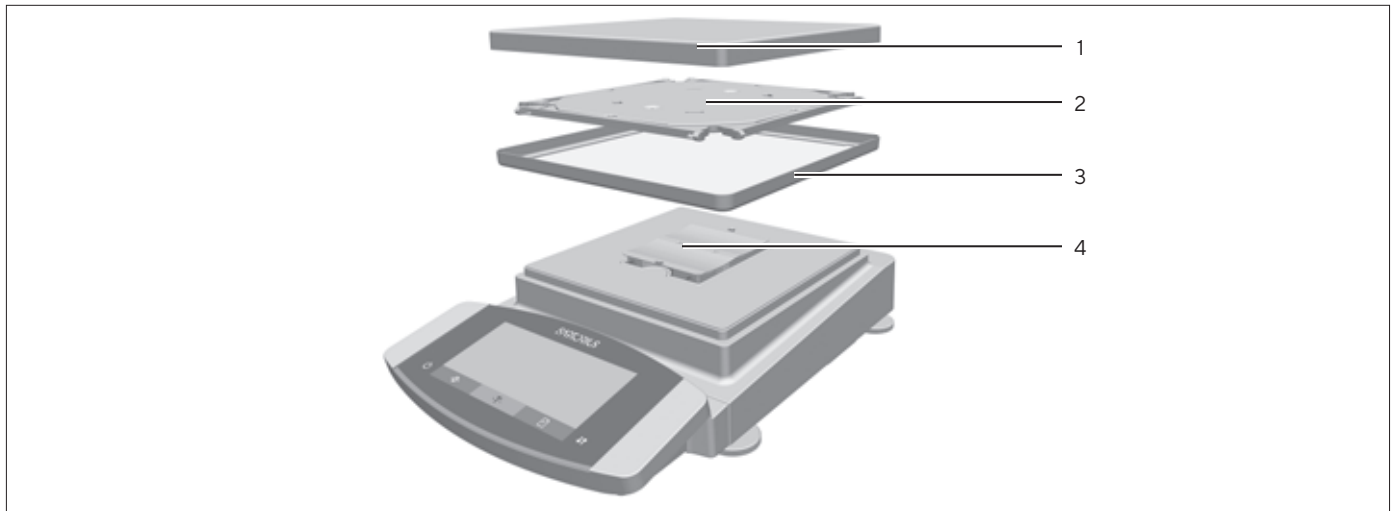

Fig. 2: Precision balance (example)

Pos.	Name
1	Weighing pan
2	Pan support
3	Shield disk
4	Pan retainer

3.3 Connections and Components on the Weighing Module

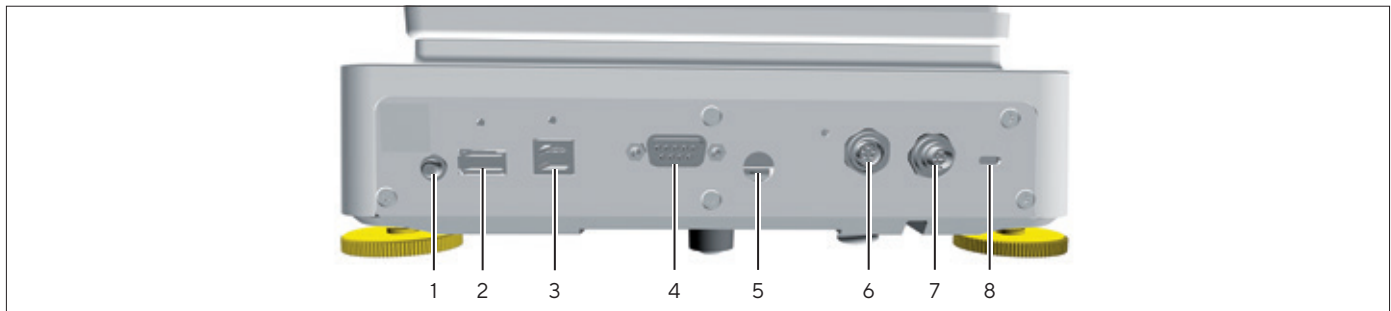

Fig. 3: Connections for weighing module

Pos.	Name	Description
1	On key	
2	USB-A connection	For printers and for software updates via a USB mass storage device
3	USB-B connection	For connection to a PC
4	COM-RS232 connection	9-pin, for connection to a PC or PLC
5	Access switch	<ul style="list-style-type: none"> - Protects the device from changes to the device settings. - Is sealed for conformity-assessed devices.
6	Peripheral connection	For connecting Sartorius accessories
7	Power supply	For connection to the power supply
8	Slot	For attaching a "Kensington" anti-theft device

3.4 Connections on the Control Unit

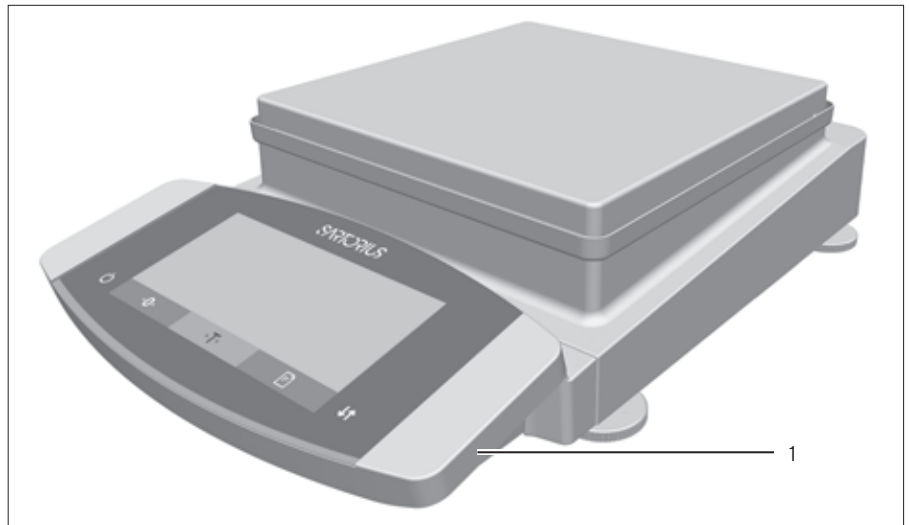

Fig.4: Connections on the control unit

Pos.	Name	Description
1	USB connection	Concealed, no function, for Sartorius Service only

3.5 Safety Equipment

3.5.1 Protective Caps on the Weighing Module

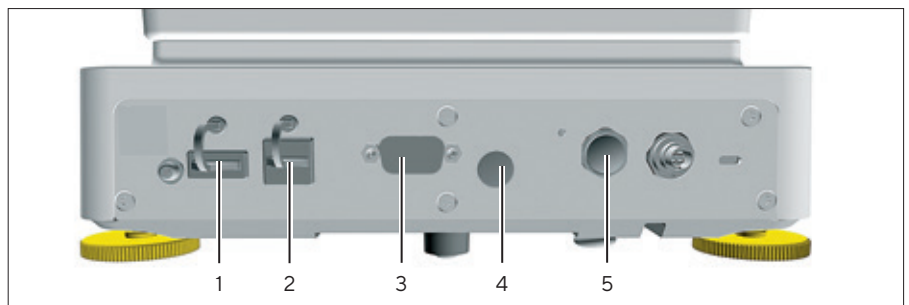

Fig.5: Connections to the Weighing Module

Pos.	Name	Description
1	Protective cap for USB-A connection	Plastic attachment hood, fastened to the device.
2	Protective cap for USB-B connection	Plastic attachment hood, fastened to the device.
3	Protective cap for COM-RS232 connection	Removable plastic sealing cap.
4	Protective cap for access switch	Removable plastic sealing cap.
5	Protective cap for peripheral connection	Removable plastic sealing cap.

3.6 Conformity-assessed Devices

Some settings of conformity-assessed models are protected against user changes, e.g. external calibration for devices in accuracy class II. This measure is intended to ensure the suitability of the devices for use in legal metrology.

3.7 Symbols on the Device



Fig. 6: ID label on the device

Pos.	Name	Description
1	Manufacturer's ID label	Displays the metrological data of the device.

4 Operating Concept

4.1 Operating Display in Weighing Mode

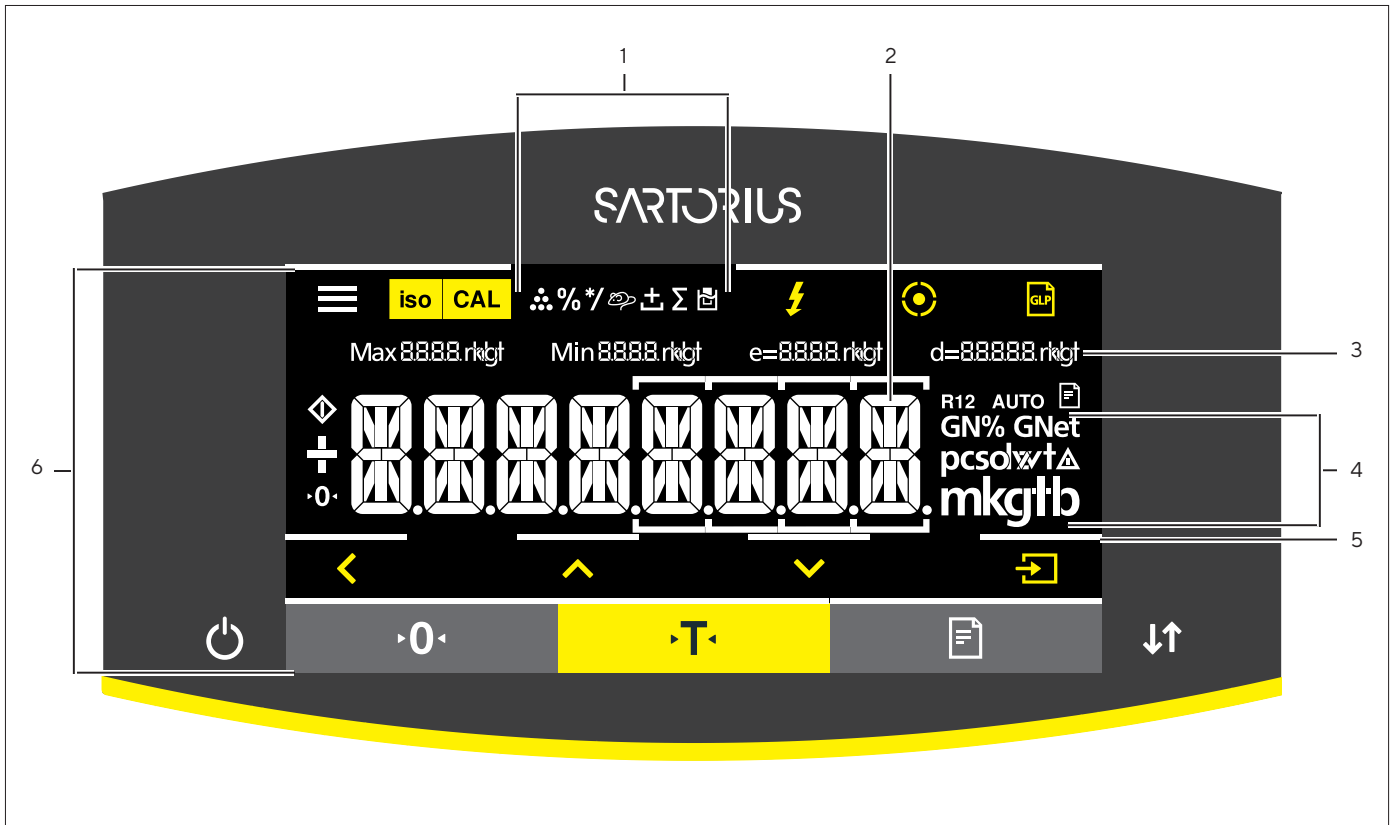

Fig. 1: Operating display in weighing mode (example)

Pos.	Name	Description
1	Symbols for the selected application	
2	Weight value display	In the selected basic unit.
3	Metrological data	
4	Weight units	Shows the selected basic unit, e.g. grams, [g].
5	Visual touch-feedback	Visual note on an active button or key.
6	Operating and display area	

4.2 Operating Display in the Menu

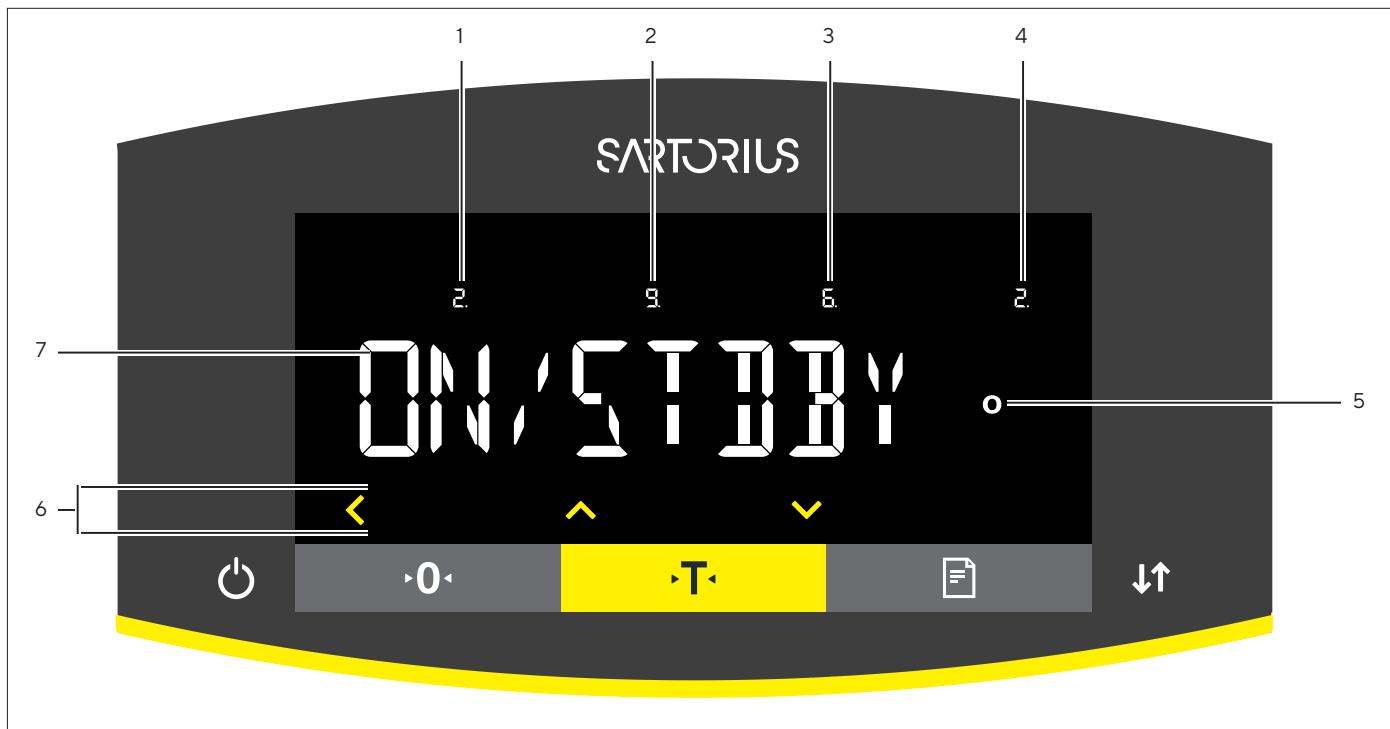

















Fig. 2: Operating display in the menu (example)

Pos.	Name	Description
1	Position in the 1st menu level	Shows the position of the displayed menu or configuration value in up to 4 menu levels.
2	Position in the 2nd menu level	
3	Position in the 3rd menu level	
4	Position in the 4th menu level	
5	[Computed values] display	Note on the set menu item
6	Operating area	
7	Name of the menu or setting	



4.3 Buttons and Keys on the Operating Display

Symbol	Name	Description
	[Menu] button	<ul style="list-style-type: none"> - When the button is pressed: The settings menu opens. - If the button is held down: It switches to version display.
	[isoCAL] button	<ul style="list-style-type: none"> - Starts the pre-set calibration or adjustment function. - When button is flashing: Starts the isoCAL function.
	[Adjust] button	Starts the set calibration and adjustment function.
	[Leveling] button	Starts a leveling process.

Symbol	Name	Description
	[GLP] button	<ul style="list-style-type: none"> - Exits the GLP printout and starts printing the GLP footer. - If the "Net-total", "Totalizing", or "Statistics" application is active: Prints and deletes the saved values and exits the application.
	[Toggle between weight units] button	<p>If the "Toggle between weight units" function is active:</p> <ul style="list-style-type: none"> - If the button is held down: Accesses the "Toggle between weight units" function menu. - When the button is pressed: Switches between the basic unit display and up to 4 other units.
	[Invalid weight value] button	If a fault exists in the weighing module: Indicates the cause of this fault.
	[Back] button	<ul style="list-style-type: none"> - In the menu: <ul style="list-style-type: none"> - When the button is pressed: Returns to the previous display. - If the button is held down: Saves the menu settings. - When entering digits: Selects the previous digit position. - For an active application: Exits the application and deletes the set reference value.
	[Up] button	<ul style="list-style-type: none"> - In the menu: Scrolls through the menu levels or the available configuration values. - When entering digits: Increases the displayed value.
	[Down] button	<ul style="list-style-type: none"> - In the menu: Scrolls through the menu levels or the available configuration values. - When entering digits: Decreases the displayed value. - In the main display of an active application: Accesses the display to set the reference values.
	[Confirm] button	<ul style="list-style-type: none"> - In the menu: Accesses the displayed menu level or confirms the displayed configuration value. - When entering digits: Selects the next digit position. - In the main display of an active application: Starts the application process and saves the set reference value.
	[On Off] key	<ul style="list-style-type: none"> - If the key is briefly pressed: Switches the operating display on. - If the key is held down: Switches the operating display off.
	[Zero] key	Zeros the device.
	[Tare] key	Starts taring.
	[Print] key	Exports the readouts to the integrated data interfaces.
	[Change] key	<ul style="list-style-type: none"> - For models without a motorized draft shield, if the "Toggle between weight units" function is active: <ul style="list-style-type: none"> - If the key is briefly pressed: Switches between the set weight units. - If the key is held down: Accesses the "Toggle between weight units" function menu.

4.4 Displays in the Operating Display

Symbol	Name	Description
	[Leveling] display	<ul style="list-style-type: none"> – Indicates that the device is leveled. – If the center circle is flashing: Indicates that the device is not leveled.
	[Leveling] display	Flashes while the device is leveling.
	[Counting] display	Indicates that the “Counting” application is selected.
	[Weighing in percent] display	Indicates that the “Weighing in percent” application is selected.
	[Calculation] display	Indicates that the “Calculation” application is selected.
	[Animal weighing] display	Indicates that the “Animal weighing” application is selected.
	[Net-total] display	Indicates that the “Net-total” application is selected.
	[Totalizing] display	Indicates that the “Totalizing” application is selected.
	[Density determination] display	Indicates that the “Density determination” application is selected.
	[Statistics] display	Indicates that the “Statistics” application is selected.
	[Busy] display	Indicates that the device is processing a command.
	[Sign] display	Indicates whether the value being displayed is positive or negative.
	[Zero] display	For some conformity-assessed devices: Indicates that the device has been zeroed.
	[AUTO] display	Indicates that the “Animal weighing” application starts automatically.
	[Data output] display	Indicates that the data output is active.
	[Percent] display	Indicates that a percentage value is being displayed.
	[Net] display	Indicates that a net value is being displayed.
	[Computed value] display	<ul style="list-style-type: none"> – In the menu: Identifies the selected configuration value. – If the “Calculation” or “Density determination” application is active: Indicates that a calculated value is being displayed.
	[Unit symbol] display	Indicates the set weight unit, e.g. [g] for “grams”.

Symbol	Name	Description
	[Quantity]	Indicates that a quantity is being displayed.
	[Invalid weight value] display	<ul style="list-style-type: none"> – Indicates that the display does not contain a weight value, rather it is the calculated result of an application, e.g. for the “Totalizing” application. – For conformity-assessed devices: Indicates a fault. The cause of this fault is displayed after pressing the [Change] key.
	[Directional arrows] display	If leveling with the inclination sensor is active: Displays the direction of rotation of the leveling foot.

4.5 Menu Structure

4.5.1 Overview of the Device Settings Menu

► Navigating in Menus (see Chapter 4.6, page 24).

Level 1	Level 2	Level 3	Description
SETUP	BALANCE	AMBIENT “Ambient conditions”	Enter the ambient conditions at the device’s installation site.
		APP FILT. “Application filter”	<ul style="list-style-type: none"> – Equalize the load deviations in the display. – The load deviations occur between the complete placement of the sample on the weighing pan and reaching the final result display.
		STABIL. “Stability range”	<ul style="list-style-type: none"> – Define the accuracy of the stability range. – If the weight unit symbol appears, the weight readout is stable within the range indicated by the stability range
		ST.DEL. “Stability delay”	<ul style="list-style-type: none"> – Define the duration of the stability delay. – The stability delay is used to bridge residual fluctuations in the vibration of the device in order to display reliable results.
		ZERO/TAR. “Zeroing and taring”	Define the trigger for zeroing and taring.
		AUTOZER. “Auto zero”	Activate deactivate automatic control of the zero display. The deviations of a set fraction of scale intervals per second starting from the display zero point are automatically zeroed.
		UNIT	<ul style="list-style-type: none"> – Define the weight unit, e.g. grams, kilograms, pounds. – Depending on the country-specific model version, not all weight units listed may be available. – Some weight units may be blocked from use in conformity-assessed devices, depending on national verification laws.

Level 1	Level 2	Level 3	Description
SETUP	BALANCE	DISP.DIG.	<ul style="list-style-type: none"> - Define whether all decimal places are displayed. - A lower display accuracy enables a faster display. - The setting option is not available on conformity-assessed devices.
		CAL./ADJ. "Adjust"	Define the function of the [Adjust] button.
		CAL.SEQ. "Calibration sequence"	Define the sequence of the "Calibrate and adjust" function.
		ON Z/T Tare / zero at power on	Activate deactivate automatic taring when starting the device.
		ISOCAL	Configure the isoCAL function.
		CAL.UNIT "Calibration weight unit"	Define the weight unit for the calibration weight.
	GEN.SERV. "General services"	MEN.RESET "Menu reset"	Reset the menu to factory settings.
DEVICE	RS-232 "COM-RS232, 9-pin"	DAT.REC.	Set the communication protocol for the connected device.
		BAUD	Set the baud rate for the connected device.
		PARITY	Set the parity for the connected device.
		HANDSHK.	Set the handshake between the balance and the device.
		DATABIT	Set the number of data bits.
	PC-USB "USB-B (Device/Slave)"	DAT.REC.	Set the communication protocol for the connected PC.
		BAUD	Set the baud rate for the connected PC.
		PARITY	Set the parity for the connected PC.
		HANDSHK.	Set the handshake between the device and the connected PC.
		DATABIT	Set the number of data bits.
	USB "USB-A (Host/ Master)"	DEV.USED "Device in use"	Display the device connected via USB-A.
	LEVELING "Leveling"	LEVEL	Define the settings for the integrated inclination sensor.
		START	Define the trigger for automatic leveling.

Level 1	Level 2	Level 3	Description	
DEVICE	MOTION.S. "Motion sensor"	CONTROL	Activate deactivate the motion sensor.	
		NUM.GEST. "Number"	Define the number of possible gestures.	
		LEFT.CMD.	Define the function for the left gesture.	
		RIGHT.CMD.	Define the function for the right gesture.	
		UP.CMD.	Define the function for the up gesture.	
		DOWN.CMD.	Define the function for the down gesture.	
	EXTRAS	MENU	Lock or unlock the menu's configuration parameters.	
		SIGNAL	Set or deactivate the acoustic signal.	
		KEYS	Activate deactivate the key lock.	
		ON MODE "Switch-on and switch-off options"	Configure the device's switch-on and switch-off options, e.g. switch between standby mode and operating mode.	
		LIGHTING	Activate deactivate the lighting for the operating display.	
	DATA.OUTP. "Data output"	COM. SBI "SBI communication"	COM.OUTP.	Configure the automatic data output.
			STOP.AUTO	Define whether the automatic data output can be stopped and started with the [Print] key.
			AUTO.CYCL. "Time-dependent interval"	Define an interval for the automatic data output.
FORMAT			Define the data output format (characters per line).	
AUTO.TARE			Activate deactivate automatic taring after the printout.	
PRNT.PARA. Printout and PC direct transfer settings		ACTIVATE "Triggers"	Define whether the printout or PC direct data output takes place with or without balance stability.	
		FORMAT	Define the format for the printout (characters per line).	
		PRT.INIT. "Initializing"	Define the settings for printer initialization.	
		GLP	Define the settings for the GLP printout.	
		TAR./PRT. "Tare / print"	Activate deactivate automatic taring after every print process.	
		TIME	Define the time format.	
		DATE	Define the date display format.	
PC.DIRECT Direct transfer of data (PC)		DEC.SEPAR.	Define the decimal separator character.	
		OUTP.FORM.	Define the output format for the data exchange between the balance and the PC.	

Level 1	Level 2	Level 3	Description
APPLIC. "Applications"	WEIGH (Factory setting)	UNIT	Activate deactivate the "Toggle between weight units" function for all applications.
	COUNT	RESOLUT.	Define the display of the weight value for the "Counting" application.
		REF.UPDT. "Reference updating"	Activate deactivate automatic reference updating for the "Counting" application.
	PERCENT "Weighing in percent"	DEC.PLCS "Decimal places"	Define the number of decimal places for the "Weighing in percent" application.
	NET-TOTL. "Net-total"	COMP.PRT. "Component printout"	Activate deactivate the component printout for the "Net-total" application.
	TOTAL "Totalizing"	COMP.PRT. "Component printout"	Activate deactivate the component printout for the "Totalizing" application.
	ANIMALW. "Animal weighing"	ACTIVITY "Animal activity"	Define the level of activity of the sample for the "Animal weighing" application.
		START	Define the trigger for starting the animal weighing.
	CALC. "Calculation"	METHOD	Define the method of calculation for the "Calculation" application.
		DEC.PLCS "Decimal places"	Define the number of decimal places for the "Calculation" application.
	DENSITY "Density determination"	DEC.PLCS "Decimal places"	Define the number of decimal places for the "Density determination" application.
	STATIST. "Statistics"	COMP.PRT. "Component printout"	Activate deactivate the component printout for the "Statistics" application.
TAR./STAT. "Tare /statistics"		Activate deactivate automatic taring for the "Statistics" application.	
UPDATE			Start a firmware update. The menu is only available if a USB mass storage device is connected.
INPUT	ID NO.		Save the entered ID number for the device.
	LOT ID		<ul style="list-style-type: none"> - Activates deactivates the printout of a line for the LOT ID in the GLP printout. - The LOT-ID can be entered in writing in the line.
	DATE		Set the date.
	TIME		Set the time.
	USER.PASS.		Set the user password.
	DEL.PASS.		Delete the user password. The menu is only available if a user password is set.
	SERV.PASS.		Activate the service mode.

Level 1	Level 2	Level 3	Description
INPUT	CAL.WT. "Calibration weight"		Define the value of the external user calibration weight.
	INTERV.		Change the interval for automatic data output for parameters "DATA.OUTP./COM.SBI /AUTO.CYCL./INTERV." and "DATA.OUTP./PRNT.PARA./ACTIVATE/INTERV.".
INFO "Device information"	VERSION "Version number"		Display the software version number.
	SER. NO. "Serial number"		Display the device's serial number.
	MODEL		Display the device's model ID.
	APC VER.		Display the software version of the APC processor.
	BAC VER.		Display the software version of the BAC processor.
	MCU VER.		Display the software version of the MCU processor.
LANGUAGE			Change the menu language.

Overview of the "Toggle between weight units" Function

► Navigating in Menus (see Chapter 4.6, page 24).

Level 1	Description
Unit 1	Define the displayed weight unit and the resolution for the 1st convertible unit.
Unit 2	Define the displayed weight unit and the resolution for the 2nd convertible unit.
Unit 3	Define the displayed weight unit and the resolution for the 3rd convertible unit.
Unit 4	Define the displayed weight unit and the resolution for the 4th convertible unit.

4.6 Navigating the Menus

Procedure



- ▶ To access the settings menu: Press the [Menu] button.



- ▶ To scroll through all menus in the same level: Press the [Up] or [Down] button.



- ▶ To switch to the displayed menu level: Press the [Confirm] button on the keypad.
- ▶ To scroll through the configuration values: Press the [Up] or [Down] button.
- ▶ To select the configuration value shown in the display or the displayed application: Press the [Confirm] button on the keypad.



- ▶ The [Value] display identifies the selected configuration value or the selected application.



- ▶ To return to the next higher menu level: Press the [Back] button.
- ▶ To exit the settings menu: In the main menu level, press the [Back] button.

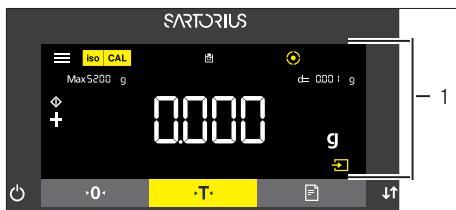

- ▶ If the start display (1) of a selected application is displayed:
 - ▶ To start the application without changing the preset reference value: Press the [Confirm] button on the keypad.
 - ▶ To change a reference value before starting the application, e.g. density value, divisor or reference quantity: Press the [Up] button.
 - ▶ The reference value display is shown for the selected application.



- ▶ If a reference value with decimal places needs to be selected in the reference value display (1) of a selected application, e.g. "Density determination" or "Calculation" applications:
 - ▶ The selected digit position flashes.
 - ▶ Use the [Up] or [Down] button to change the value for the selected digit position.
 - ▶ If a digit position other than the last digit position is selected: Press the [Confirm] button to select the next digit position.
 - ▶ If a digit position other than the first digit position is selected: Press the [Back] button to select the previous digit position.
 - ▶ If the last digit position is selected: Press the [Confirm] button to save the displayed reference value and start the application process.
 - ▶ If the first digit position is selected: Press the [Back] button to delete the displayed reference value and return to the application's status display.

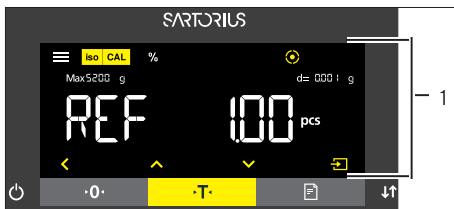

- ▶ If an integer reference value needs to be selected in the reference value display (1) of a selected application, e.g. “Weighing in percent” or “Animal weighing” applications:
 - ▶ Press the [Up] or [Down] button. This increases or decreases the reference value by 1.
 - ▶ Hold down the [Up] or [Down] button. This increases or decreases the reference value by 10.
 - ▶ To start the application: Press the [Confirm] button on the keypad.
 - ▶ To delete the displayed reference value and return to the application’s status display: Press the [Back] button.

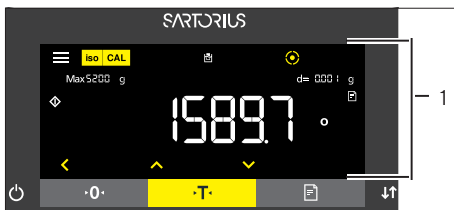

- ▶ If the results display (1) of a selected application is displayed:
 - ▶ To switch between the application results display and the set reference value display: Press the [Up] or [Down] button.
 - ▶ To exit the results, display and delete the set reference value and the result of the application: Press the [Back] button.

5 Installation

5.1 Scope of Delivery

Item	Quantity
Device	1
Weighing pan	1
Shield plate	1
Pan support	1
Power supply unit	1
Country-specific power supply cable with test seal	1
USB connection cable	1
In-use dust cover for control unit	1
In-use dust cover for the weighing module	1

5.2 Selecting an Installation Site

Procedure

► Ensure that the following conditions are met at the installation site:

Condition	Features
Ambient conditions	Suitability tested (see Chapter “15.3 Ambient Conditions”, page 68)
Setup surface	<p>Stable, even surface that is not exposed to vibrations</p> <p>Not directly against a wall</p> <p>Sufficiently dimensioned for the device and the peripheral devices (device space requirements see Chapter “15.1 Dimensions and Weight”, page 67; peripheral device space requirements see instructions for the peripheral devices, e.g. printer)</p> <p>Sufficient load-bearing capacity for the device and the peripheral devices even when full (device weight see Chapter “15.1 Dimensions and Weight”, page 67; weight of the peripheral devices see instructions for the peripheral devices, e.g. printer)</p>
Access	Barrier-free

5.3 Unpacking the Device

Procedure

- ▶ Unpack the device at the intended installation location.
- ▶ Lift the device in the Styrofoam padding out of the packaging.
- ▶ Place the device in the Styrofoam padding on its side.
- ▶ Lift the Styrofoam padding off the device.
- ▶ Place the device on its base.
- ▶ Keep all parts of the original packaging, e.g. to return the device.

5.4 Removing the Control Unit

The control unit can be removed for all models. This enables the flexible setup of the control unit at the workplace.

Tool: 1 Torx Allen key, T20

Material: 1 soft support base

Requirements

The weighing pan and all associated components are **not** placed on the device, e.g. shield ring, pan support.

Procedure

- ▶ Turn over the device and place on a soft surface.

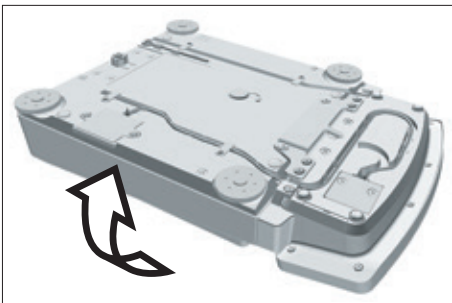

- ▶ To loosen the control unit's retainer: Use the Torx Allen key to remove both screws.
- ▶ Remove the control unit and re-insert both screws into the threaded holes.

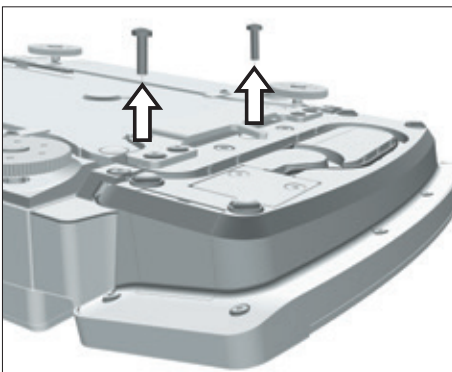

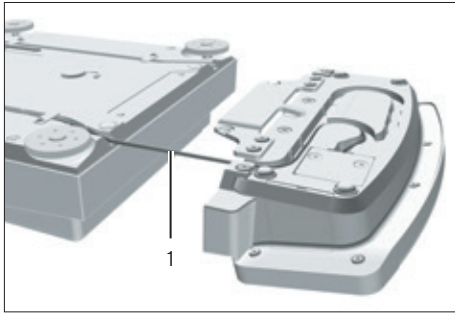

- ▶ Carefully pull the connection cable between the control unit and the weighing module (1) out of the control unit's retainer and unroll it.

- ▶ Turn the device over again and place it on an even surface.

5.5 Preparing Below-cell Weighing

Samples that **cannot** be placed on the weighing pan can be mounted to the device base and weighed using the below-cell weighing equipment.

M

In legal metrology:

- Do **not** use the below-cell weighing equipment.
- Do **not** open the cover of the below-cell weighing equipment.

Material: 1 soft support base

Requirements

The weighing pan and all associated components are **not** placed on the device, e.g. shield ring, pan support.

Procedure

- ▶ Turn over the device and place on a soft surface.

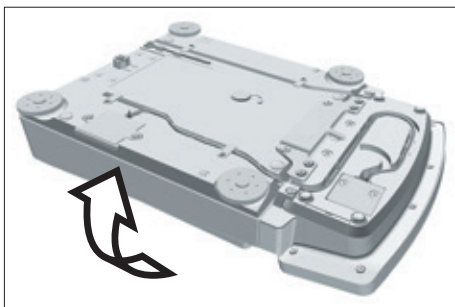

- ▶ Remove the hook for below-balance weighing (1) from the retainer on the underside of the base of the device.

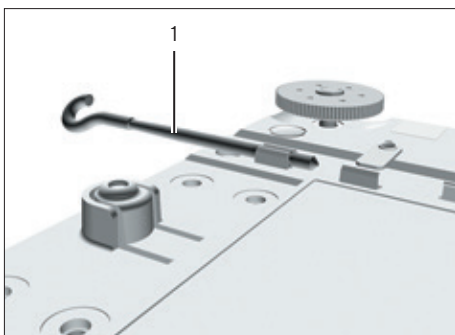

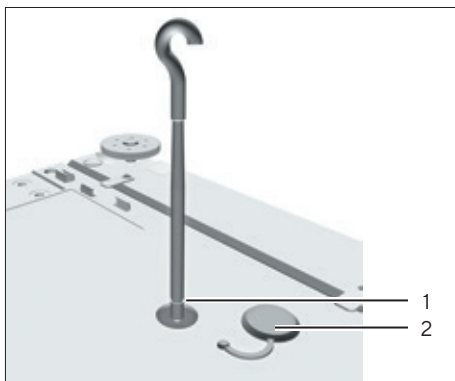

- ▶ Pull the cover of the below-balance weighing equipment out.
- ▶ **NOTICE** Damage to the device from cross-threading! Ensure that the hook for below-balance weighing is inserted straight into the thread opening (1).

- ▶ Install a draft protection shield.
- ▶ Suspend the sample on the hook for below-balance weighing, e.g. with a wire.
- ▶ To cover the below-balance weighing equipment after weighing:
 - ▶ Remove the hook for below-balance weighing from the thread.
 - ▶ Return the hook for below-balance weighing to its retainer on the underside of the weighing module.
 - ▶ Re-insert the cover of the below-balance weighing equipment.

5.6 Positioning the Weighing Pan and Associated Components

Procedure

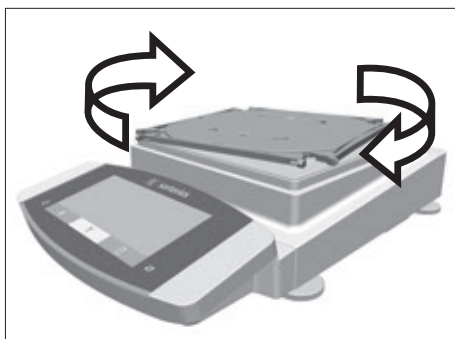

- ▶ Position the pan support down onto retainer, diagonally to the weighing module, and press slightly.
- ▶ Carefully turn the pan support clockwise until the two buttons engage.
- ▶ The pan support is now attached.

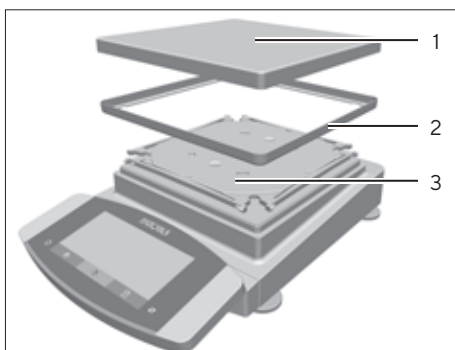

- ▶ Place the shield plate (2) on the weighing module (3).
- ▶ Place the weighing pan (1) on the pan support.

5.7 Acclimatization

When a cold device is brought into a warmer area: The temperature difference can lead to condensation of humidity in the device (moisture formation). Moisture in the device can lead to malfunctions.

- ▶ Allow the device to acclimatize for approx. 2 hours at the installation site. Ensure that the device is disconnected from the power supply during that time.

6 Getting Started

6.1 Connecting Electronic Components

Procedure

- ▶ **⚠ CAUTION** Improper connection may damage the device! If the device is connected using electronic components, e.g. printer, PC: The device must be disconnected from the power supply. Ensure that the device is disconnected from the power supply.
 - ▶ Connect the device using electronic components (see electronic components instructions).

6.2 Installing the AC Adapter

Procedure

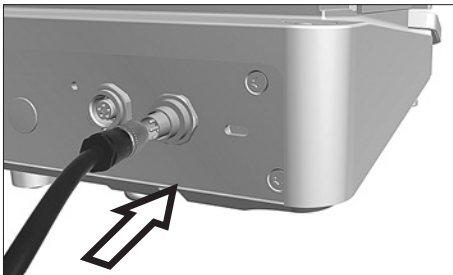

- ▶ Plug the DC supply cable of the AC adapter into the device's "power supply" connection socket and tighten the threaded fitting.

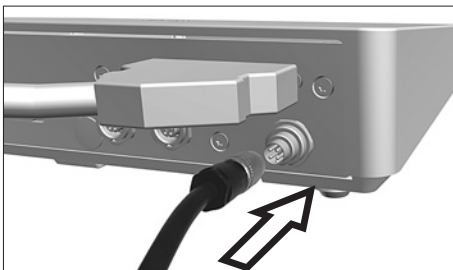

- ▶ If this relates to a device with an electronics module: Plug the DC supply cable of the AC adapter into the electronics module's "power supply" connection socket and tighten the threaded fitting.

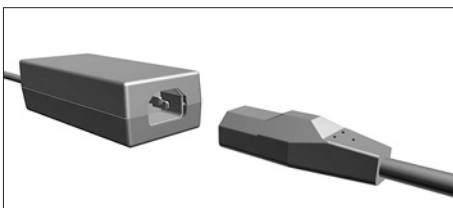

- ▶ Connect the power supply cable to the AC adapter connection.

6.3 Connecting the Power Supply

Procedure

- ▶ **⚠ WARNING** Severe injuries caused by using a defective power supply cable!
Check the power supply cable for damage, e.g., cracks in the insulation.
 - ▶ If required: Contact Sartorius Service.
- ▶ Check whether the country-specific power plug matches the power connections at the installation site.
 - ▶ If required: Contact Sartorius Service.
- ▶ **NOTICE** Damage to the device due to excessive input voltage! Check whether the voltage specifications on the AC adapter match those of the power supply at the installation site.
 - ▶ If the input voltage is too high: Do **not** connect the device to the power supply.
 - ▶ Contact Sartorius Service.
- ▶ Connect the mains plug of the power supply cable to the wall outlet at the installation site.
- ▷ The [BOOTING] display appears in the operating display.
- ▷ The device performs a self-test.
- ▷ The device performs an initial tare function.

6.4 Attaching the Protective Caps

If connections of the device are not being used during operation, the connections must be sealed with the protective caps supplied.

Procedure

- ▶ Check whether all unused connections have been sealed with a protective cap.
- ▶ Attach the protective caps (1) for any unused electrical connections.

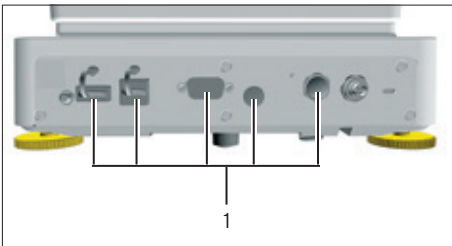

7 System Settings

7.1 Performing System Settings

Default settings can be adjusted for the device and the applications in order to align with the ambient conditions and individual operating requirements.

The following settings are necessary to operate the device together with connected components:

- Set up the communication of the connected devices
- Set up additional components

The following settings are recommended to set up the device:

- Set the menu language
- Set the behavior of the isoCAL function
- Set the behavior of the motorized draft shield (only for devices with a motorized draft shield)

Procedure

- ▶ Press the [Menu] button.
- ▶ Open the desired settings menu.
- ▶ To adjust settings: Open the desired main menu and submenu.
- ▶ Select and confirm the desired configuration value (configuration values, see Chapter "7.3 Parameter List", page 34).
- ▶ Exit the menu.
- ▷ If settings have been adjusted in the "SETUP", "DEVICE", "DATA.OUTP." or "APPLIC." menu: The [BOOTING] display appears in the operating display and the device restarts.

7.2 Switching Off the isoCAL Function

M

If the isoCAL function is switched off for a conformity-assessed device, the device can only be used for legal-for-trade applications in restricted temperature ranges (see Chapter "15.3.2 Ambient Temperature for the isoCAL Function", page 69). The isoCAL function cannot be switched off for all model versions.

Procedure

- ▶ In the "SETUP"/"BALANCE" menu, select the "OFF" configuration value for the "ISOCAL" parameter.

7.3 Parameter List

7.3.1 Parameters in the "Setup" Main Menu

Parameters in the "Balance" Submenu

Parameters	Setting values	Explanation
AMBIENT	V.STABLE	Sets the ambient conditions to "very stable": Activates a fast change in the weight values in the event of a load change with a high output rate. Recommended for the following work environment: <ul style="list-style-type: none"> - Very stable table near the wall - Closed and calm room
	STABLE*	Sets the ambient conditions to "stable". Recommended for the following work environment: <ul style="list-style-type: none"> - Stable table - Slight movement in the room - Slight draft
	UNSTABL.	Sets the ambient conditions to "unstable": Activates the delayed change in weight values with a reduced output rate. Recommended for the following work environment: <ul style="list-style-type: none"> - Simple office desk - Room with moving machinery or personnel - Slight air movement
	V.UNSTBL.	Sets the ambient conditions to "very unstable": Activates a significantly delayed change in the weight values and long wait for stability with a further reduction in the output rate. Recommended for the following work environment: <ul style="list-style-type: none"> - Noticeable and slow floor vibrations - Noticeable building vibrations - Weighed goods moved - Very strong air movements
APP FILT.	FINAL.RD.*	<ul style="list-style-type: none"> - Activates a filter that enables a fast change in the display for very fast load changes. - Display changes with minimal load changes (in the digit range) occur more slowly.
	FILLING	Activates a filter that enables a very fast change in the display with minimal load changes (e.g. when filling containers).
	REDUC.	Activates a weak but fast filter that always behaves in the same way for load changes (e.g. when filling automated systems).
	OFF	Deactivates the active application filter.
STABIL.	MAX ACC.	Sets the stability to "maximum accuracy".
	V. ACC.	Sets the stability to "very accurate".
	ACC.*	Sets the stability to "accurate".
	FAST	Sets the stability to "fast".
	V. FAST	Sets the stability to "very fast".
	MAX.SPEED	Sets the stability to "maximum speed".

* Factory setting

Parameters	Setting values	Explanation
ST.DEL.	NONE	Sets the stability delay to "none": The stability symbol is displayed after the stability criterion is reached.
	SHORT*	Sets the stability delay to "short": The stability symbol only appears after a short delay in order to provide a reliable result despite fluctuations.
	MEDIUM	Sets the stability delay to "medium": The stability symbol only appears after a longer delay in order to provide a reliable result in case of higher fluctuations.
	LONG	Sets the stability delay to "long": The stability symbol only appears after a long delay in order to balance out major instability.
ZERO/TAR.	W/O STB.	Without stability: The function of the [Zero] or [Tare] key is executed immediately once the key is pressed.
	W/ STAB.*	With stability: The function of the [Zero] or [Tare] key is only executed after stability is achieved.
	AT STAB.	At stability: The function of the [Zero] or [Tare] key is executed if stability exists when the key is pressed.
AUTOZER.	ON*	Activates automatic zeroing. The display is automatically set to zero in case of a deviation of 0 less than (X).
	OFF	Deactivates automatic zeroing. Zeroing must be triggered with the [Zero] key.
UNIT		The availability of units may depend on national legislation and is therefore country-specific.
	GRAMS*	The device displays the weight in grams.
	KILOGR.	The device displays the weight in kilograms (not for semi-microbalances and microbalances).
	CARATS	The device displays the weight in carats.
	POUNDS	The device displays the weight in pounds (not for semi-microbalances and microbalances).
	OUNCES	The device displays the weight in ounces (not for microbalances).
	TROY OZ.	The device displays the weight in troy ounces (not for microbalances).
	HKTAEL	The device displays the weight in taels – Hong Kong (not for microbalances).
	SNGTAE	The device displays the weight in taels – Singapore (not for microbalances).
	TWNTAE	The device displays the weight in taels – Taiwan (not for microbalances).
	GRAINS	The device displays the weight in grains.
	PENYWT.	The device displays the weight in pennyweights.
	MILLIGR.	The device displays the weight in milligrams (not for high-capacity precision balances).
	CHINATAEL	The device displays the weight in taels – China (not for microbalances).
	MOMMES	The device displays the weight in mommes.
	TOLA	The device displays the weight in tolas.
BAHT	The device displays the weight in baht (not for microbalances).	
MESGHAL	The device displays the weight in mesghals.	
NEWTON	The device displays the weight in newtons (not for microbalances).	

* Factory setting

Parameters	Setting values	Explanation
DISP.DIG.	ALL*	“Show all decimal places”: All decimal places are shown in the display. Not available on conformity-assessed devices.
	LP.ON/OFF	“Reduced by 1 decimal place for load change”: The last decimal place on the display is switched off until stability is achieved.
	DIVIS. 1	“Last decimal place of the 1st division”: The last decimal place always shows the 1st division.
	MINUS 1	“Last decimal place off”: The last decimal place is switched off.
CAL./ADJ.	EXT.CAL.	The [Adjust] button starts an external calibration with the preset calibration weight.
	E.CAL.USR.	The [Adjust] button starts an external calibration with the user-defined calibration weight value.
	INT.CAL.*	The [Adjust] button starts an internal calibration.
CAL.SEQ.	ADJUST*	Calibration and adjustment is one routine.
	CAL.-ADJ.	Adjustment must be started or exited manually after calibration with the [Adjust] button.
ON Z/T	ON*	<ul style="list-style-type: none"> – Activates the initial taring zeroing. – The device is tared or zeroed after it is switched on.
	OFF	Deactivates the initial taring zeroing: After it is switched on, the device shows the value before it was last switched off.
ISOCAL	OFF	Switches the isoCAL function off.
	NOTE TO	<ul style="list-style-type: none"> – The [isoCAL] button flashes if the balance needs to be adjusted. – The isoCAL function must be manually triggered with the [Adjust] button.
	ON*	<ul style="list-style-type: none"> – Activates the isoCAL function. – The device is automatically adjusted as soon as a trigger starts the isoCAL function.
CAL.UNIT	GRAMS*	Changes the calibration weight unit to grams.
	KILOGR.	Changes the calibration weight unit to kilograms (not for semi-microbalances and microbalances).
	CONF.UNIT	Changes the calibration weight unit to milligrams (not for precision balances and high-capacity precision balances).

* Factory setting

Parameters in the “General Services” Submenu

Parameters	Setting values	Explanation
MEN.RESET	YES	Resets the system settings to the factory default settings.
	NO*	Deactivates the option of resetting the device menu.

* Factory setting

7.3.2 Parameters in the “Device” Main Menu

Parameters in the “Extras” Submenu

Parameters	Setting values	Explanation
MENU	EDITABLE*	Activates write access: The menu parameters can be changed.
	RD.ONLY	Activates read access: The menu parameters cannot be changed.
SIGNAL	OFF	Switches the acoustic signal off.
	QUIET	Sets the volume of the acoustic signal to “quiet”.
	MEDIUM*	Sets the volume of the acoustic signal to “medium”.
	LOUD	Sets the volume of the acoustic signal to “loud”.
KEYS	UNLOCKED*	Deactivates the key lock.
	LOCKED	Activates the key lock. Only the [On Off], [Menu], [Zero], and [Tare] keys can be used.
ON MODE	ON/STDBY*	<ul style="list-style-type: none"> - The [On Off] key switches between on standby. - Switch on with the [On Off] key.
	ON/OFF	<ul style="list-style-type: none"> - The [On Off] key switches between on off. - Switch on with the on key.
	AUTO ON	Changes the function of the [On Off] key: The device no longer switches off or to standby mode, instead it starts a boot process.
LIGHTING	OFF	Deactivates the lighting on the operating display.
	ON*	Activates the lighting on the operating display.

* Factory setting

Parameters in the “Leveling” Submenu

Parameters	Setting values	Explanation
LEVEL	OFF	The device does not display messages on the status of the level.
	NOTE*	The [LEVELING] display flashes if the device needs to be leveled.
	ERR.MSG.	The [LEVEL.ERR.] message appears in the operating display if the device has not been leveled.
START	KEY	Sets the trigger for leveling to “key”: Leveling must be started manually by pressing the [Leveling] button.
	AUTO*	Sets the trigger for leveling to “automatic”: The device automatically performs a leveling function using the integrated sensor before every internal calibration adjustment.

* Factory setting

Parameters in the “Sensor” Submenu

Parameters	Setting values	Explanation
CONTROL	OFF	Deactivates the motion sensor: No gestures are recognized.
	ON*	Activates the motion sensor.
NUM.GEST.	2 GESTUR.*	Activates the control of functions with 2 gestures. Gestures: Left, right
	4 GESTUR.	Activates the control of functions with 4 gestures. Gestures: Left, right, top, bottom
LEFT.CMD.	PRINT*	Left command of the gesture control corresponds to the [Print] key.
	ZERO	Left command of the gesture control corresponds to the [Zero] key.
	TARE	Left command of the gesture control corresponds to the [Tare] key.
	NONE	No function is assigned to the left command of the gesture control.
RIGHT.CMD.	PRINT*	Right command of the gesture control corresponds to the [Print] key.
	ZERO	Right command of the gesture control corresponds to the [Zero] key.
	TARE	Right command of the gesture control corresponds to the [Tare] key.
	NONE	No function is assigned to the right command of the gesture control.
UP.CMD.	PRINT*	Upper command of the gesture control corresponds to the [Print] key.
	ZERO	Upper command of the gesture control corresponds to the [Zero] key.
	TARE	Upper command of the gesture control corresponds to the [Tare] key.
	NONE	No function is assigned to the upper command of the gesture control.
DOWN.CMD.	PRINT*	Lower command of the gesture control corresponds to the [Print] key.
	ZERO	Lower command of the gesture control corresponds to the [Zero] key.
	TARE	Lower command of the gesture control corresponds to the [Tare] key.
	NONE	No function is assigned to the lower command of the gesture control.

* Factory setting

Parameters in the “COM-RS232” Submenu

Parameters	Setting values	Explanations
DAT.REC.	SBI.WEIGH.	Enables a faster SBI communication, only for software commands to the weighing module.
	XBPI	Extended range of commands to control numerous balance functions with binary protocol for direct communication with the weighing module.
	SBI*	<ul style="list-style-type: none"> – Enables SBI communication. – The data is output to a PC or control unit. – Enables the use of ESC commands from a PC to control the basic balance functions with ASCII protocol.
	OFF	Deactivates the automatic data output.

* Factory setting

Parameters	Setting values	Explanations
BAUD	600	Sets the baud rate to 600 baud.
	1200	Sets the baud rate to 1200 baud.
	2400	Sets the baud rate to 2400 baud.
	4800	Sets the baud rate to 4800 baud.
	9600*	Sets the baud rate to 9600 baud.
	19200	Sets the baud rate to 19200 baud.
	38400	Sets the baud rate to 38400 baud.
	57600	Sets the baud rate to 57600 baud.
PARITY	115200	Sets the baud rate to 115200 baud.
	ODD*	Applies an odd parity.
	EVEN	Applies an even parity.
HANDSHK.	NONE	Does not apply a parity.
	SOFTWARE	Sets the handshake protocol to software handshake.
	HARDWARE*	Sets the handshake protocol to hardware handshake.
DATABIT	NONE	Does not set a handshake protocol.
	7 BITS	Sets the number of data bits to 7.
	8 BITS*	Sets the number of data bits to 8.

* Factory setting

Parameters in the "PC-USB" Submenu

Parameters	Setting values	Explanations
DAT.REC.	SBI.WEIGH.	Enables a faster SBI communication, only for software commands to the weighing module.
	XBPI	Extended range of commands to control numerous balance functions with binary protocol for direct communication with the weighing module.
	SBI*	<ul style="list-style-type: none"> - Enables SBI communication. - The data is output to a PC or control unit. - Enables the use of ESC commands from a PC to control the basic balance functions with ASCII protocol.
	PC.SPREAD.	Enables data output to a spreadsheet program via a direct PC connection.
	PC.TEXT	Enables a direct PC connection to be established to a text processing program.
	OFF	Deactivates the data output.

* Factory setting

Parameters	Setting values	Explanations
BAUD	600	Sets the baud rate to 600 baud.
	1200	Sets the baud rate to 1200 baud.
	2400	Sets the baud rate to 2400 baud.
	4800	Sets the baud rate to 4800 baud.
	9600*	Sets the baud rate to 9600 baud.
	19200	Sets the baud rate to 19200 baud.
	38400	Sets the baud rate to 38400 baud.
	57600	Sets the baud rate to 57600 baud.
	115200	Sets the baud rate to 115200 baud.
PARITY	ODD*	Applies an odd parity.
	EVEN	Applies an even parity.
	NONE	Does not apply a parity.
HANDSHK.	HARDWARE	Sets the handshake protocol to hardware handshake.
	NONE*	Does not set a handshake protocol.
DATABIT	7 BITS	Sets the number of data bits to 7.
	8 BITS*	Sets the number of data bits to 8.

* Factory setting

Parameters in the “USB” Submenu

Parameters	Setting values	Explanation
DEV.USED	NONE*	Indicates that no device connection is detected at the USB port.
	[Device Designation]	Displays the designation of the devices connected to the USB port.

* Factory setting

7.3.3 Parameters in the “Data Output” Main Menu

Parameters in the “SBI Communication” Submenu

Parameters	Setting values	Explanations
COM. OUTP.	IND.NO*	Starts the data output after pressing the key or software command as an individual value without stability.
	IND.AFTER	Starts the data output after pressing the key or software command as an individual value without stability.
	AUTO W/O	Activates the automatic data output without stability.
	AUTO W/	Activates the automatic data output after stability.

* Factory setting

Parameters	Setting values	Explanations
STOP.AUTO	OFF*	Deactivates the option to abort the automatic data output.
	ON	The automatic data output is aborted by pressing the [PRINT] key or a software command.
AUTO.CYCL.	EACH VAL*	Starts the automatic data output with a cycle after each value.
	2. VALUE	Starts the automatic data output with a cycle after every 2nd value.
	INTERV.	Starts the automatic data output at the output rate set under "INPUT / INTERV."
FORMAT	16 CHARS	Data output provides 16 characters per line (16 characters for the measured values only).
	22 CHARS*	Data output provides 22 characters per line (16 characters for the measured values and 6 characters for identifiers).
	EXTR.LINE	Data output provides an additional line with the date, time, and weight value.
AUTO.TARE	OFF*	Deactivates automatic taring after data output.
	ON	The device automatically tares after data output.

* Factory setting

Parameters in the "Settings for Printouts" Submenu

Parameters	Setting values	Explanation
ACTIVATE	MAN. NO	Manual without stability: Print process can be started manually at any time.
	MAN.AFTER*	Manual after stability: After pressing the [Print] key, the print command is only executed once stability is achieved.
	INTERV.	Starts the automatic data output at the output rate set under "INPUT / INTERV."
	AUTO.LC	Automatically at load change: Print process starts after every load change.
FORMAT	22 CHARS*	Printer output prints 22 characters per line (16 characters for the measured values and 6 characters for identifiers)
	EXTR.LINE	Printer output prints an additional line with the date, time, and weight value.
PRINT.INIT	OFF	Deactivates the output of the application parameters.
	ALL*	Print command prints all parameters.
	MAIN PAR.	Print command only prints the main parameters.
GLP	OFF*	Deactivates the GLP printout.
	CAL.-ADJ.	Activates the GLP printout for all calibration and adjustment processes.
	ALWAYS	<ul style="list-style-type: none"> - The GLP printout is always switched on. - All printouts contain a GLP header and a GLP footer.
TAR./PRT.	OFF*	Deactivates automatic taring after printer output.
	ON	Automatically tares the device after every printout.

* Factory setting

Parameters	Setting values	Explanation
TIME	24H*	Sets the time to 24-hour mode.
	12H	<ul style="list-style-type: none"> - Sets the time to 12-hour mode (AM PM). - Locked when date format YYYY.MM.DD (ISO) is activated.
DATE	DD.MMM.YY*	Sets the date display format to DD.MMM.YY
	MMM.DD.YY	Sets the date display format to MMM.DD.YY
	YYYY.MM.DD	Sets the date display format to YYYY.MM.DD (ISO).

* Factory setting

Parameters in the “PC Direct Transfer” Submenu

Parameters	Setting values	Explanations
DEC.SEPAR.	DEC.POINT*	Sets a point as a decimal separator.
	DEC.COMMA	Sets a comma as a decimal separator.
OUTP.FORM.	TEXT+NUM.*	Exports text and numbers.
	ONLY NUM.	Only exports numbers.

* Factory setting

7.3.4 Parameters in the “Applications” Main Menu

Parameters in the “Weighing” Submenu

Parameters	Setting values	Explanation
UNIT	ON*	Activates the “Toggle between weight units” function.
	OFF	Deactivates the “Toggle between weight units” function.

* Factory setting

Parameters in the “Counting” Submenu

Parameters	Setting values	Explanation
RESOLUT.	DISP.ACC.*	<ul style="list-style-type: none"> - Sets the resolution to “display resolution”. - The “Counting” application is started with the displayed value.
	10-FOLD	Sets the resolution to 10-times more accurate than “display resolution”.
	100-FOLD	Sets the resolution to 100-times more accurate than “display resolution”.
REF.UPDT.	OFF*	Deactivates automatic reference sample updating.
	AUTO	Activates the automatic reference sample updating.

* Factory setting

Parameters in the “Weighing in Percent” Submenu

Parameters	Setting values	Explanation
DEC.PLCS	NONE	The result of the “Weighing in Percent” application is displayed without decimal places.
	1 DEC.PL.*	The result of the “Weighing in Percent” application is displayed to 1 decimal place.
	2 DEC.PL.	The result of the “Weighing in Percent” application is displayed to 2 decimal places.
	3 DEC.PL.	The result of the “Weighing in Percent” application is displayed to 3 decimal places.

* Factory setting

Parameters in the “Net-Total” Submenu

Parameters	Setting values	Explanation
COMP.PRT.	OFF	Deactivates the component printout.
	ON*	Activates the component printout.

* Factory setting

Parameters in the “Totalizing” Submenu

Parameters	Setting values	Explanation
COMP.PRT.	OFF	Deactivates the component printout.
	ON*	Activates the component printout.

* Factory setting

Parameters in the “Animal Weighing” Submenu

Parameters	Setting values	Explanation
ACTIVITY	CALM	<ul style="list-style-type: none"> - Sets the intensity of the “Animal activity” to “calm”. - Recommended for minor movements of the sample, e.g. caused by placement on the weighing pan.
	MEDIUM*	<ul style="list-style-type: none"> - Sets the intensity of the “Animal activity” to “medium”. - Recommended for medium movements of the sample, e.g. caused by placement on the weighing pan.
	V.ACTIVE	<ul style="list-style-type: none"> - Sets the intensity of the “Animal activity” to “very active”. - Recommended for very active movements of the sample, e.g. caused by placement on the weighing pan.
START	MANUAL	The “Animal weighing” application must be manually selected in the start screen.
	AUTO*	Sets the trigger to start the “Animal weighing” application to “automatic”.

* Factory setting

Parameters in the "Calculation" Submenu

Parameters	Setting values	Explanation
METHOD	MUL.*	Specifies multiplication as the method of calculation for the "Calculation" application.
	DIV.	Specifies division as the method of calculation for the "Calculation" application.
DEC.PLCS	NONE	The result of the "Calculation" application is displayed without decimal places.
	1 DEC.PL.*	The result of the "Calculation" application is displayed to 1 decimal place.
	2 DEC.PL.	The result of the "Calculation" application is displayed to 2 decimal places.
	3 DEC.PL.	The result of the "Calculation" application is displayed to 3 decimal places.

* Factory setting

Parameters in the "Density Determination" Submenu

Parameters	Setting values	Explanation
DEC.PLCS	NONE	The result of the "Density determination" application is displayed without decimal places.
	1 DEC.PL.*	The result of the "Density determination" application is displayed to 1 decimal place.
	2 DEC.PL.	The result of the "Density determination" application is displayed to 2 decimal places.
	3 DEC.PL.	The result of the "Density determination" application is displayed to 3 decimal places.

* Factory setting

Parameters in the "Statistics" Submenu

Parameters	Setting values	Explanation
COMP.PRT.	OFF	Deactivates the component printout.
	ON*	Activates the component printout.
TAR./STAT.	OFF*	Deactivates automatic taring after the components are saved.
	ON	Activates automatic taring after the components are saved.

* Factory setting

7.3.5 Parameters in the “Input” Main Menu

Parameters	Setting values	Explanation
ID NO.	Maximum of 8 characters 09-0, A-Z, -, space	Saves the entered ID number for the device.
LOT ID	OFF*	Deactivates the prompt of lot ID number during data output.
	ON	- Activates the prompt of the lot ID number during data output. - The LOT-ID can be entered in writing in the line.
DATE		Saves the entered date.
TIME		Saves the entered time.
USER.PASS.	Maximum of 8 characters 09-0, A-Z, -, space	Saves the entered user password.
DEL.PASS.	YES	Deletes the entered user password.
	NO*	Does not delete the entered user password.
SERV.PASS.	Max 8 characters 09-0, A-Z, -, empty	Activates service mode.
CAL.WT.		Changes the calibration weight for the adjustment or calibration process with the user-defined weight value.
INTERV.	0-9999 seconds	- Changes the interval for automatic data output for parameters “DATA. OUTP./COM.SBI /AUTO.CYCL./INTERV.” and “DATA.OUTP./PRNT. PARA./ACTIVATE/INTERV.”. - “0” activates the fastest output rate (generally 100 ms).

* Factory setting

7.3.6 Parameters in the “Language” Main Menu

Parameters	Setting values	Explanation
LANGUAGE	ENGLISH*	English
	DEUTSCH	German
	FRANCAIS	French
	ITALIANO	Italian
	ESPANOL	Spanish
	PORTUG.	Portuguese
	PYCCКИЙ	Russian
	POLSKI	Polish

* Factory setting

7.3.7 Parameters in the “Unit 1”, “Unit 2”, “Unit 3”, and “Unit 4” Function Menus

Parameters	Setting values	Explanation
		The availability of units may depend on national legislation and is therefore country-specific.
NONE*		Switches the toggle between weight units off for this position.
GRAMS – Newton	NONE*	The configuration values for the [DISP.DIG.] parameter in the [BALANCE] menu are saved for the scale interval ([DISP.DIG.] parameter see 7.3, 34).
	ALL	“Show all decimal places”: All decimal places are shown in the display.
	LP.ON/OFF	“Reduced by 1 decimal place for load change”: The last decimal place on the display is switched off until stability is achieved.
	DIVIS. 1	“Last decimal place of the 1st division”: The last decimal place always shows the 1st division.
	MINUS 1	“Last decimal place off”: The last decimal place is switched off and the measured value is rounded up or down by one decimal place.
* Factory setting		

8 Operation

8.1 Switching the Device On and Off

The device only delivers accurate values if it has reached the necessary operating temperature. The warm-up time after switching the device on must therefore be complied with.

Procedure

- ▶ Connect the device to the power supply.
 - ▶ If the device does not switch on automatically after it is connected to the power supply: Press the on key on the electronics module.
 - ▶ To allow the device to reach the necessary operating temperature to accurately determine the weight: Comply with the warm-up time of 2 hours after switching the device on.
- M

 - ▷ If this relates to a conformity-assessed device: The weight value is marked as invalid during the warm-up period.
 - ▶ **NOTICE** Damage to the device when disconnecting the weighing module and electronics module! The connection of the weighing module and the electronics module must not be disconnected during operation.
 - ▶ Level and adjust the device.
 - ▷ The device is ready for use.
 - ▶ **NOTICE** Pointed or sharp-edged objects may damage the operating display! Touching the operating display with objects, such as pens, may damage the touchscreen surface of the operating display. Only touch the operating display with your fingertips.
 - ▶ To switch the device off: Press and hold the [On | Off] key.

8.2 Leveling the Device

8.2.1 Leveling the Device with the Level

Leveling compensates any inclines at the device's installation site. Minor inclines can be compensated with the front leveling feet. If leveling is necessary: The level's air bubble is not located within the circle marking.

Procedure

- ▶ Retract both rear leveling feet.
- ▶ Turn the front leveling feet (2) until the level's air bubble is located in the center of the circle marked on the level (1).

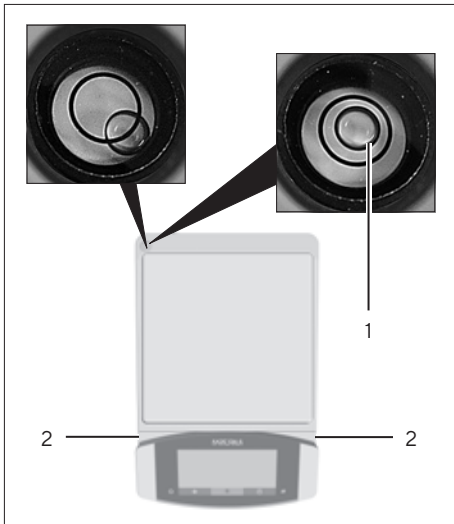

- ▶ For models with rear leveling feet: Screw out both rear leveling feet until they touch the setup surface.

8.2.2 Leveling a Device with Manual Feet with Inclination Sensor

The inclination sensor detects inclines in the alignment of the device. If leveling is necessary: The "Leveling" display flashes.

Procedure

- ▶ Press the [Leveling] button.
- ▷ The leveling process starts.
- ▷ The [RETRACT] display appears.
- ▶ Retract both rear leveling feet.
- ▶ Press the "Confirm" button on the keypad.
- ▷ The "Directional arrows" display and the [TURN] display appear in the operating display for every leveling foot.
- ▶ Turn the front leveling feet in the direction indicated by the "Directional arrows" display until the "Directional arrows" display disappears for both leveling feet.

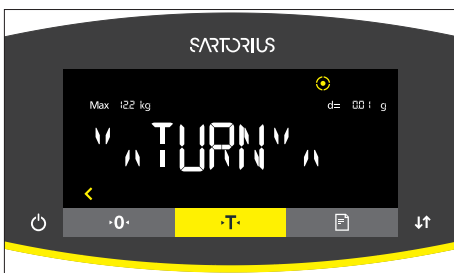

- ▷ The [EXTEND] display appears.
- ▶ Screw out both rear leveling feet until they touch the setup surface.
- ▷ Press the [Confirm] button on the keypad.

8.2.3 Leveling a Device with Motorized Feet

Devices with motorized feet are leveled automatically. If leveling is necessary: The [Leveling] display flashes.

Procedure

- ▶ Press the [Leveling] button.
- ▷ The [Leveling] display flashes.
- ▷ The device levels itself automatically using the motorized leveling feet.

8.3 Preparing Weighings

The device must be prepared before every weighing.

Requirements

The device is ready for use

NOTICE

Chemicals may damage the device or accessories!

Chemicals can attack the device or the connected accessories internally and externally. This may damage the device and accessories.

- ▶ Use appropriate containers when weighing chemicals.
-

Procedure

- ▶ Level the device.
- ▶ Zero the device for calibration. To do so, press the [Zero] key.
- ▶ If the device **cannot** be zeroed: Remove the sample to be weighed and re-zero the device.
- ▶ Calibrate the device.

8.4 Weighing

Procedure

- ▶ Zero the device.
- ▶ If necessary, place a container for the sample on the device.
- ▶ To compensate the weight of the container: Tare the device. To do so, press the [Tare] key.
- ▶ If a container is used for the sample: Place the sample in the container.
- ▶ If **no** container is used for the sample: Place the sample on the weighing pan.
- ▶ Once the weight value no longer changes and the weighing unit is displayed: Read off the measured value.

8.5 Overview of Calibration, and Adjustment

During calibration, a calibration weight is used to determine how much the displayed value deviates from the actual value. This deviation is compared against a preset target value. The subsequent adjustment eliminates this deviation.

Calibration and adjustment must be performed regularly:

- Daily, every time the device is switched on
- After every leveling
- After changing the ambient conditions (temperature, humidity, or air pressure)
- After setting the device up at a new installation site

Calibration and adjustment may be performed in different ways:

- Adjusting with the isoCAL function
- Internal or external calibration or adjustment

M

Only internal calibration | adjustment is possible for all conformity-assessed devices in legal metrology.

8.6 Adjusting with the isoCAL Function

The device can be automatically internally calibrated and adjusted using the isoCAL function.

Requirements

- The device is **not** located in the menu.
- Alphanumeric inputs are **not** active.
- The load on the weighing pan remains unchanged for 2 minutes.
- The load on the weighing pan amounts to no more than 2% of the maximum load.
- The device does **not** register an input for 2 minutes.

If all requirements for starting the isoCAL function are met and one of the following conditions occurs: The isoCAL function is automatically triggered.

Possible conditions are:

- The ambient temperature has changed since the last adjustment | calibration.
- The interval time was exceeded (interval time, see Chapter "15.8 Recommended Calibration Weight", page 74).
- The device has been leveled.
- The device has been disconnected from the power supply since the last adjustment | calibration (only for conformity-assessed models).

Procedure

- ▶ If the isoCAL auto-start function is set (configuration values for the "ISOCAL" parameter, see Chapter "7.3.1 Parameters in the "Setup" Main Menu", page 34):
 - ▷ If the isoCAL function is triggered according to the aforementioned conditions: The [isoCAL] button flashes in the operating display.
 - ▷ In the operating display, a time display counts down from 15 seconds to 0.
 - ▷ If **no** load change or **no** operation takes place on the device before the expiration of the time display: The isoCAL function starts.
- ▶ If the isoCAL manual start function is set (configuration values for the "ISOCAL" parameter, see Chapter "7.3.1 Parameters in the "Setup" Main Menu", page 34):
 - ▷ If the isoCAL function is triggered: The [isoCAL] button flashes in the operating display.
 - ▶ Press the [isoCAL] button.
 - ▷ The isoCAL function starts.

8.7 Internally Calibrating and Adjusting the Device

Calibration and Subsequent Adjustment

Requirements

- The weighing pan is unloaded.
- The operating display shows a stable weight value.

Procedure

- ▶ To set the internal adjustment in the menu: In the "SETUP" / "BALANCE" menu, for the "CAL./ADJ." parameter, select the "INT.CAL." configuration value.
- ▶ To set the sequence of the adjustment function to calibration and subsequent automatic adjustment: In the "SETUP" / "BALANCE" menu, for the "CAL.SEQ." parameter, select the "ADJUST" configuration value.
- ▶ Exit the menu.
- ▶ Press the [Zero] key.
- ▶ To start the internal calibration | adjustment: Press the [Adjust] button.
- ▶ If automatic leveling is set for a model with motorized adjusting feet: The device levels itself automatically.
 - ▷ The internal calibration weight is loaded.
 - ▷ The [CAL.RUN.] display appears in the operating display during calibration.
 - ▷ The device is automatically calibrated and the internal calibration weight is removed.
 - ▷ The [CAL.END] display indicates the end of calibration.

Manually Starting Adjustment after Calibration

Requirements

- The weighing pan is unloaded.
- The operating display shows a stable weight value.

Procedure

- ▶ To set the internal adjustment in the menu: In the "SETUP"/"BALANCE" menu, for the "CAL./ADJ." parameter, select the "INT.CAL." configuration value.
- ▶ To set the sequence of the adjustment function to calibration without subsequent automatic adjustment: In the "SETUP"/"BALANCE" menu, for the "CAL.SEQ." parameter, select the "CAL/ADJUST" configuration value.
- ▶ Exit the menu.
- ▶ Press the [Zero] key.
- ▶ To start the internal calibration: Press the [Adjust] button.
- ▷ The internal calibration weight is loaded.
- ▷ The [CAL.RUN.] display appears in the operating display during calibration.
- ▷ The calibration weight value is shown.
- ▶ To start adjustment: Press the [Confirm] button on the keypad.
- ▷ The device is calibrated and the internal calibration weight is removed.
- ▷ The [CAL.END] display indicates the end of calibration.

8.8 Externally Calibrating and Adjusting the Device (Not for Conformity-assessed Models)

External Calibration with Factory Set Weight Value

Procedure

- ▶ In the "SETUP"/"BALANCE" menu, for the "CAL./ADJ." parameter, select the "EXT.CAL." configuration value.

Set the User-defined Weight Value

A weight value can be set for the calibration weight. This user-defined weight value is used for the external calibration.

If no user-defined weight value is set: The preset weight value is used.

Procedure

- ▶ In the "INPUT" menu, select the "CAL.WT." configuration value.
- ▶ Enter and confirm the desired weight value.
- ▶ To use the user-defined weight value for the next calibration: In the "Balance" menu, for the "CAL./ADJ." parameter, select the "E.CAL.USR." configuration value.

Calibration and Subsequent Adjustment

Requirements

- The weighing pan is unloaded.
- The operating display shows a stable weight value.
- The device is not locked against external calibration.
- Keep calibration weight ready for use.

Procedure

- ▶ To set the external calibration in the menu: In the "SETUP"/"BALANCE" menu, for the "CAL./ADJ." parameter, select external calibration with preset calibration weight or external calibration with user-defined calibration weight as described above.
- ▶ To set the sequence of the adjustment function to calibration and subsequent automatic adjustment: In the "SETUP"/"BALANCE" menu, for the "CAL.SEQ." parameter, select the "ADJUST" configuration value.
- ▶ Exit the menu.
- ▶ Press the [Zero] key.
- ▶ Press the [Adjust] button.
- ▶ Place the indicated calibration weight on the balance. The device is automatically adjusted after calibration, if the calibration weight placed on the device is within the specified limits.
 - ▷ The [+] sign is shown if the applied weight is too high.
 - ▷ The [-] sign is shown if the applied weight is too low.
- ▷ The [CAL.END] message indicates the end of calibration.
- ▶ Remove the calibration weight after calibration is complete.

Manually Starting Adjustment after Calibration

Requirements

- The weighing pan is unloaded.
- The operating display shows a stable weight value.
- The device is not locked against external calibration.

Procedure

- ▶ To set the external calibration in the menu: In the "SETUP"/"BALANCE" menu, for the "CAL./ADJ." parameter, select external calibration with preset calibration weight or external calibration with user-defined calibration weight as described above.
- ▶ To set the sequence of the adjustment function to calibration without subsequent automatic adjustment: In the "SETUP"/"BALANCE" menu, for the "CAL.SEQ." parameter, select the "CAL/ADJUST" configuration value.
- ▶ Exit the menu.
- ▶ Press the [Zero] key.
- ▶ Press the [Adjust] button.

- ▶ Place the indicated calibration weight on the balance. The calibration can only be started, if the calibration weight used is within the defined limits.
 - ▷ The [+] sign is shown if the applied weight is too high.
 - ▷ The [-] sign is shown if the applied weight is too low.
- ▶ Press the [Confirm] button on the keypad. This starts the calibration.
- ▷ The [CAL.END] display indicates the end of calibration.
- ▶ Remove the calibration weight after calibration is complete.

8.9 Printing Results

The results of the calibration can be printed in a GLP printout.

Procedure

- ▶ Set the GLP printout in the menu (setting parameters, see Chapter "Parameters in the "Settings for Printouts" Submenu", page 41):
- ▶ Calibrate the device.
- ▷ Once the calibration is complete:
 - ▷ The printing process starts.
 - ▷ The GLP footer is printed.

8.10 Weighing and Printing with ID Marking

The device and every lot can be assigned an ID number. The ID numbers are provided in the GLP header during GLP-compliant printing.

Requirements

- The ID marking is entered in the menu, e.g. "BATCH1" (see Chapter "7.3.5 Parameters in the "Input" Main Menu", page 45).
- The printing of the lot ID line in the GLP printout is activated in the menu (see Chapter "7.3.5 Parameters in the "Input" Main Menu", page 45).
- The GLP-compliant printout is activated (see Chapter "7.3.5 Parameters in the "Input" Main Menu", page 45).
- The format for the printout is set to 22 characters per line (configuration parameters, see Chapter "7.3.3 Parameters in the "Data Output" Main Menu", page 40).

```

-----
23-Apr-2020    13:06
      Sartorius
Mod.          MCE6202S
Ser. no.      12345678
Ver. 09-05-00.09.01
ID           CHARGE01
-----
L  ID
G          +    50.12 g
-----
23-Apr-2020    13:07

```

Procedure

- ▶ Start the printout. To do so, press the [Print] key.
- ▶ The GLP header is printed with the ID marking set in the menu and the current weight value.
- ▶ The [GLP] button appears in the operating display.
- ▶ To exit the GLP printout: Press the [GLP] button.
- ▷ The GLP footer is printed.

8.11 Running Applications (Examples)

8.11.1 Executing the "Toggle Between Weight Units" Function

The "Toggle between weight units" function enables a switch between the basic unit display and up to 4 other units. The units can be set during the weighing process and the decimal places can be adjusted.

The basic unit is displayed every time the device is started.

Procedure

- ▶ To activate the "Toggle between weight units" function in the menu: In the "BALANCE" menu, for the "UNIT" parameter, select the "ON" configuration value.
- ▶ Exit the settings menu.
- ▷ The device boots up.
- ▶ To select the convertible units: Press and hold down the "Toggle between weight units" button of the "Change" key.
- ▶ The "Toggle between weight units" function menu opens.
- ▶ Select a submenu from "Unit 1" - "Unit 4".
- ▶ Select the desired unit and confirm the display (available units, see Chapter "7.3.7 Parameters in the "Unit 1", "Unit 2", "Unit 3", and "Unit 4" Function Menus", page 46).
- ▶ To set the number of display digits for the selected unit: Press the "Confirm" button (configuration parameters, see Chapter "7.3.7 Parameters in the "Unit 1", "Unit 2", "Unit 3", and "Unit 4" Function Menus", page 46).

- ▶ Select the desired number of display digits and confirm the selection.
- ▶ Exit the "Toggle between weight units" function menu.
- ▷ The current weight value is displayed in the selected unit.
- ▶ To switch the displayed mass unit during weighing or before starting an application: Press the "Toggle between weight units" button or the "Change" key multiple times if necessary, until the desired unit is displayed.
- ▷ The current weight value is displayed in the selected unit.

8.11.2 Running the "Statistics" Application

The "Statistics" application saves up to 99 weight values and evaluates these statistically.

The following values are saved and exported by the statistics application:

- Number of components
- Mean value
- Standard deviation
- Variation coefficient
- Sum of all values
- Lowest value (minimum)
- Highest value (maximum)
- Spread: Difference between maximum and minimum

The "Statistics" application can be combined with the following functions:

- Toggle between weight units only available before starting the application
- ID marking
- Automatic taring

Procedure

- ▶ Select the Statistics application in the "APPLIC." menu.
- ▶ Exit the settings menu.
- ▶ Place a sample on the weighing pan.
- ▶ Change the displayed weight unit if necessary.
- ▶ To start the recording of the statistics: Press the [Confirm] button on the keypad.
- ▷ The current weight value is saved.

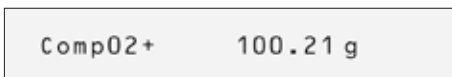

- ▶ To save the next value:
 - ▶ Remove the sample on the weighing pan.
 - ▶ Place a new sample on the weighing pan and press the [Confirm] button.

n		6
x	+	100.258 g
s	+	0.037 g
sRel	+	0.04 %
Sum	+	601.55 g
Min	+	100.21 g
Max	+	100.31 g
Diff	+	0.10 g

- ▶ To switch between the display of the current weight value, the number of saved components, and the calculated mean in the results display: Press the [Up] or [Down] button.
- ▶ To print and exit the current statistics, and to delete the saved values: Press the [Back] or [GLP] button.

9 Cleaning and Maintenance

9.1 Preparing the Device

Procedure

- ▶ Turn the device off.
- ▶ Disconnect the device from the power supply.
- ▶ Remove the weighing pan and all associated components from the weighing module, e.g. shield plate, pan support.

9.2 Cleaning the Device

NOTICE

Corrosion or damage to the device due to unsuitable cleaning agents!

- ▶ Do **not** use corrosive, chloride-containing, or aggressive cleaning agents.
 - ▶ Do **not** use cleaning agents that contain abrasive ingredients, e.g. scouring agents, steel wool.
 - ▶ Do **not** use solvent-based cleaning agents.
 - ▶ Check whether the cleaning agents used are compliant materials (see Chapter "15.4 Materials", page 70).
 - ▶ Make sure that cleaning materials, such as cloths, are only slightly damp.
-

Procedure

- ▶ **NOTICE** Malfunction or damage to the device due to the ingress of moisture or dust!
 - ▶ Remove dust and powdery sample residue with a brush or hand-held vacuum cleaner.
- ▶ **NOTICE** Corrosion or damage to the weighing pan due to unsuitable cleaning agents
 - ▶ Wipe down the weighing pan and the shield plate with a cleaning agent and a cloth. The cleaning agent must be suitable for stainless steel and titanium.
- ▶ Wipe the associated components of the weighing pan with a brush or a damp cleaning cloth, e.g. shield plate, support pan.
- ▶ Wipe the device housing with a damp cloth. For more severe contamination, use a mild soap solution.

Tip

We recommend cleaning the weighing pan on a regular basis, e.g. weekly. Do not allow deposits to form on the weighing pan.

Protective oil may be applied to the weighing pan for additional protection. The protective oil must be suitable for stainless steel and titanium.

9.3 Assembling and Connecting the Device

Procedure

- ▶ Re-insert all components into the device (for insertion, see, Chapter “5.6 Positioning the Weighing Pan and Associated Components”, page 29).
- ▶ Re-connect the device to the power supply (see Chapter “6.3 Connecting the Power Supply”, page 32).

9.4 Maintenance Schedule

Interval	Component	Action	Chapter, page
Monthly to every 2 years, depending on the operating conditions	Entire system	Contact Sartorius Service	17, 78

9.5 Performing a Software Update

A software update can be installed from a USB mass storage device using the device’s USB-A connection.

Requirements

- The device is switched on.
- The software update is saved on a USB mass storage device.

Procedure

- ▶ Download the software update from the Sartorius website onto the USB mass storage device.
- ▶ If this relates to a zip file: Unzip the software update on a USB stick.
- ▶ Insert the USB mass storage device with the software update into the device’s USB-A connection.
- ▶ Access the configuration menu and select the [UPDATE] main menu.
- ▶ In the [UPDATE] main menu, select the [EXECUTE?] parameter.
- ▷ The [COPYING] display appears in the operating display.
- ▷ The [REBOOT] display appears in the operating display and the device restarts.
- ▷ The [UNPACK] display appears in the operating display.
- ▷ The [RESTART] display appears in the operating display and the device restarts.
- ▷ During the restart, the [CHECK.APC] display appears first. The [PROG APC] display then appears in the operating display for about 2 minutes.
 - ▶ Do **not** switch off the device!
- ▷ The device confirms successful installation with the [PROG OK] display.
- ▷ All identified components are updated with the new firmware.
- ▷ The device confirms the end of the installation process with the [FINISH] display.
- ▷ The device restarts.
- ▷ The device is ready for use.

10 Malfunctions

10.1 Status Messages

Status Message	Fault	Cause	Remedy	Chapter, page
OLDER?	If a USB mass storage device with a software update is connected: The device detects an obsolete update version.	The software update version is older than the software version on the device.	To perform the update anyway: Confirm the display.	
LOCKED	A software update is to be installed on a conformity-assessed device.	Software updates are not permitted for conformity-assessed devices.	If the software update has received corresponding approval: The software update can be uploaded into the device by Sartorius Service. Re-verification may then be necessary.	
INVALID.	If a USB mass storage device with a software update is connected: The device cannot find a valid update.	No valid manufacturer software updates exist on the connected USB mass storage device.	Check whether files exist on the USB mass storage device. Procure the software update files from Sartorius Service.	

10.2 Warning Messages

Warning Message	Fault	Cause	Remedy	Chapter, page
APP.ERR.	The device has measured an invalid weight value.	The applied weight is too low. The weight value is negative. No sample has been placed on the balance.	Increase the applied weight to more than the minimum load. Place the sample on the balance.	
DIS.ERR.	The value to be output cannot be shown in the operating display.	The data to be displayed is not compatible with the set display format.	Adjust the display settings in the menu, e.g. resolution, unit, decimal places.	
HIGH	The device is overloaded.	The device's maximum weighing capacity has been exceeded	Reduce the applied weight to below the device's maximum weighing capacity.	
LEVEL.ERR.	The device is not measuring a weight value.	The device is not leveled.	Level the device.	8.2, 47

Warning Message	Fault	Cause	Remedy	Chapter, page
LOW	The modulation of the weighing converter inside the weighing module is too low.	<ul style="list-style-type: none"> - No weighing pan has been placed on the balance. - A previously forgotten weight was removed after starting the device. 	Insert the weighing pan into the device and switch the device off and on again.	
ERR 54		An error exists in the weighing system or in the device electronics.	Contact Sartorius Service.	
CHK.ERR.	The internal storage medium is faulty.	A memory error exists in the firmware.	Perform a software update. If the problem occurs again: Contact Sartorius Service.	9.5, 59
COMM.ERR.	The device is not receiving any weight values.	No communication exists between the control unit and the weighing module.	Wait until the control unit restores the communication with the weighing module. If the problem occurs again: Contact Sartorius Service.	
ELISE.ERR.	No communication with the inclination sensor.	A memory error exists in the firmware.	Switch the device off and on again. If the problem occurs again: Contact Sartorius Service.	
MOTOR.ERR.	The device cannot be leveled.	The device's incline is too great or a motorized foot is defective.	Change the installation site. If the problem occurs again: Contact Sartorius Service.	
PRT.ERR.	The [Print] key is locked.	The data interface for print output is set to xBPI mode. The handshake is active and not used by the connected periphery device.	Reset the menu to the factory settings. Deactivate the handshake. If the problem occurs again: Contact Sartorius Service.	
SYS.ERR.	The system data is faulty.	A memory error exists in the control unit.	Switch the device off and on again. If the problem occurs again: Contact Sartorius Service.	
ERR 02	The device cannot be calibrated when starting the calibration function due to a zero point error.	<p>The device was not tared or zeroed before calibration.</p> <p>The device is loaded.</p>	<ul style="list-style-type: none"> - Tare or zero the device. - Check the preload and set if necessary. <p>Remove the sample from the weighing pan.</p>	

Warning Message	Fault	Cause	Remedy	Chapter, page
ERR 10	Taring is not possible.	The device cannot be manually tared because an application program has the tare memory reserved.	To release the tare memory: Exit the application program with the [Back] button.	
ERR 11	The weight value cannot be saved in the tare memory.	The weight value is negative or "zero".	<ul style="list-style-type: none"> - Check the sample being weighed. - Zero the device before placing the sample on the balance if necessary. 	
ERR 520 to ERR 527	The component replacement is faulty. The software update could not be completed.	The firmware versions of the available components do not match.	<p>Check the device's firmware.</p> <hr/> <p>Perform a software update.</p> <hr/> <p>If the problem occurs again: Contact Sartorius Service.</p>	9.5, 59

10.3 Troubleshooting

Fault	Cause	Remedy	Chapter, page
The operating display is blank.	The device is disconnected.	Check the connection to the power supply.	6.3, 32
	The AC adapter is not connected.	Connect the power supply cable to the power supply.	6.3, 32
The displayed weight value changes constantly.	The installation site is unstable.	Adjust the parameter for the ambient conditions.	
	A foreign object is positioned between the weighing pan and the housing.	Remove the foreign object.	5.2, 26
The weight readout displayed by the device is obviously wrong.	The device was not calibrated.	Calibrate the device.	
	The device was not tared before weighing.	Tare the device.	
The [Leveling] display flashes.	The device must be leveled.	Level the device.	8.4, 49

Fault	Cause	Remedy	Chapter, page
For a conformity-assessed device: The [Invalid weight value] display appears.	– The cause of this fault is displayed after pressing the [Invalid value] key. At the same time, the “Toggle between weight units” function is locked.		
	– LEVEL.ERR.: The device must be leveled.	Level the device.	8.2, 47
	– ISOCAL.ER.: The device must be calibrated.	Calibrate the device.	
	– WARMUP.xx.: The device is in the warm-up phase and has not yet reached its operating temperature. xx = remaining time in minutes	Comply with the warm-up time after switching the device on.	5.2, 26
	– VALUE.ERR.: The displayed value is invalid.	Set the device to zero.	

11 Decommissioning

11.1 Decommissioning the Device

Procedure

- ▶ Turn the device off.
- ▶ Disconnect the device from the power supply.
- ▶ Disconnect the device from all connected devices and all accessories, e.g. printer or electronics module.
- ▶ Clean the device (see Chapter "9.2 Cleaning the Device", page 58).
- ▶ Re-insert all components into the device (see Chapter "9.1 Preparing the Device", page 58, Chapter "9.3 Assembling and Connecting the Device", page 59).
- ▶ If below-balance weighing has been set up:
 - ▶ Turn the device on its side and place it on a soft support base.
 - ▶ Remove the hook for below-balance weighing from the thread.
 - ▶ Insert below-balance cap (1) back into the opening (2) in the device base and screw in with a suitable screwdriver.
 - ▶ Insert the hook for below-balance weighing (2) into its retainer on the underside of the weighing module.
 - ▶ Re-insert the cover of the below-balance weighing equipment (1).
 - ▶ Place the device on the device base on a level surface.

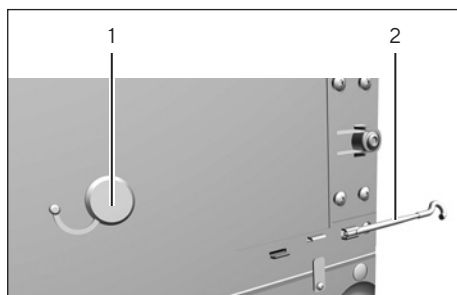

12 Transport

12.1 Transporting the Device

Procedure

- ▶ Only lift the device by its base.
- ▶ When lifting and transporting, ensure that **no** personnel or objects are in the way.
- ▶ Get help from additional persons when lifting and transporting the device.
- ▶ Use suitable conveyance devices, e.g., trolleys, for long transport routes.

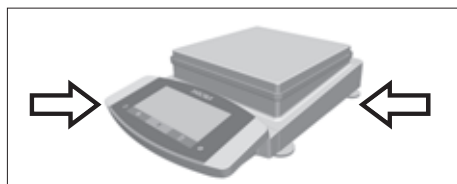

13 Storage and Shipping

13.1 Storage

Procedure

- ▶ Turn the device off.
- ▶ Disconnect the device from the power supply.
- ▶ Disconnect the device from all connected devices and all accessories, e.g. printer.
- ▶ Clean the device (see Chapter "9.2 Cleaning the Device", page 58).
- ▶ Store the device according to the ambient conditions (see Chapter 15.3, page 68).

13.2 Returning Device and Parts

Defective devices or device components can be returned to Sartorius. Returned devices must be clean, decontaminated, and properly packed, e.g. in the original packaging.

Transport damage as well as measures for subsequent cleaning and disinfection of the device or device components by Sartorius shall be charged to the sender.

WARNING

Risk of injury due to contaminated devices!

Devices contaminated with hazardous materials (nuclear, biological, or chemical – NBC) will **not** be accepted for repair or disposal.

- ▶ Observe the information on decontamination (see Chapter 14.1, page 66).
-

Procedure

- ▶ Switch off the device.
- ▶ Disconnect the device from the power supply.
- ▶ Disconnect the device from all connected devices and all accessories, e.g. printer.
- ▶ Clean the device.
- ▶ Contact Sartorius Service for instructions on how to return devices or device components (please refer to www.sartorius.com for return instructions).
- ▶ Pack the device and the device components properly for return, e.g. in the original packaging.

14 Disposal

14.1 Information on Decontamination

The device does **not** contain any hazardous materials that would necessitate special disposal actions.

Contaminated samples used during the process are potentially hazardous materials that could cause biological or chemical hazards.

If the device has come into contact with hazardous substances: Steps must be taken to ensure proper decontamination and declaration. The operator is responsible for adhering to local government regulations on the proper declaration of transport and disposal and the proper disposal of the device.

WARNING

Risk of injury due to contaminated devices!

Devices contaminated with hazardous materials (NBC contamination) will **not** be accepted by Sartorius for repair or disposal.

14.2 Dispose of Device and Parts

14.2.1 Information on Disposal

The device and the device accessories must be disposed of properly by disposal facilities.

A lithium cell battery, type CR2032, is installed inside the device. Batteries must be disposed of properly by disposal facilities.

The packaging is made of environmentally friendly materials that can be used as secondary raw materials.

14.2.2 Disposal

Requirements

The device has been decontaminated.

Procedure

- ▶ Dispose of the device. Follow the disposal instructions on our website (www.sartorius.com).
- ▶ Inform the disposal facility that there is a lithium cell battery, type CR2032, installed inside the device.
- ▶ Dispose of the packaging in accordance with local government regulations.

15 Technical Data

15.1 Dimensions and Weight

15.1.1 Precision Balance

	Unit	Value
Dimensions (L × W × H)	mm	425 × 240 × 95
Weighing pan size	mm	206 × 206
Weight, approx.	kg	5.4

15.2 Power Supply

15.2.1 Device

Only by Sartorius AC adapter YEPS03-15V0

15.2.2 Power Supply Unit

	Unit	Value
Item No.		YEPS03-15V0
Primary		
AC voltage	V	100 - 240 (±10%)
Frequency	Hz	50 - 60 (±5%)
Current consumption, maximum	A	1.0
Secondary		
DC voltage at 2 A output current	V	14.25 - 15.75
Power, maximum	W	30
Short circuit protection: Electronic		
Protection class according to IEC 62368-1		I
Pollution level according to IEC 61010-1		2
Overvoltage category according to IEC 606641-1		II
Installation site according to IEC 62368-1, maximum altitude above sea level	m	5000

	Unit	Value
Temperature		
In operation	°C	0 – +40
During storage and transport	°C	-20 – +80
Connector for mains connection according to IEC 60320-1 C14: 3-pin		
Power supply cable		
Power supply cable according to IEC 60320-1 C14: Country-specific, 3-pin, two-sided plug		
Other data: See label on AC adapter		

15.2.3 Safety of Electrical Equipment

According to EN 61010-1/IEC 61010-1 Safety requirements for electrical equipment for measurement, control, and laboratory use – Part 1: General Requirements

15.2.4 Electromagnetic Compatibility

Interference resistance

Suitable for use in industrial areas

Transient emissions

Class B

Suitable for use in residential areas and areas that are connected to a low voltage network that also supplies residential buildings.

15.3 Ambient Conditions

15.3.1 Installation Site

	Unit	Value
Installation site		
Standard laboratory rooms		
Installation site according to IEC 60259-1, maximum altitude above sea level	m	3000
For indoor use only		
Temperature		
In operation	°C	+5 – +40
In operation for conformity-assessed devices: See information on the device's ID plate		
During storage and transport	°C	-20 – +60

	Unit	Value
Relative humidity		
At temperatures of up to 31°C	%	80
Then linear decrease from 80% at 31°C to 50% at 40°C		
No heat from heating systems or direct sunlight		
No drafts from open windows, AC systems, or doors		
No vibrations		
No "heavy traffic" areas (personnel)		
No electromagnetic fields		
No dry air		

15.3.2 Ambient Temperature for the isoCAL Function

		MCE14202S	MCE14202P	MCE10202S	MCE8202S
	Unit	Value	Value	Value	Value
Scope of application as per Directive 2014/31/EU					
With isoCAL function	°C	+10 - +30	+10 - +30	+10 - +30	+10 - +30
Without isoCAL function	°C	+17 - +27	+17 - +27	+17 - +27	+10 - +30

		MCE6202S	MCE6202P	MCE4202S	MCE2202S
	Unit	Value	Value	Value	Value
Scope of application as per Directive 2014/31/EU					
With isoCAL function	°C	+10 - +30	+10 - +30	+10 - +30	+10 - +30
Without isoCAL function	°C	+10 - +30	+10 - +30	+10 - +30	+10 - +30

		MCE1202S	MCE12201S	MCE8201S	MCE5201S
	Unit	Value	Value	Value	Value
Scope of application as per Directive 2014/31/EU					
With isoCAL function	°C	+10 - +30	+10 - +30	+10 - +30	+10 - +30
Without isoCAL function	°C	+10 - +30	+10 - +30	+10 - +30	+10 - +30

15.3.3 Protection Class

	Value
IP protection according to IEC 60529-1	IP 54

15.4 Materials

Housing: Die-cast aluminum, plastic PBT, Optiwhite float and stainless steel 1.4401|1.4404, PA handles, aluminum trim

Control unit: Plastic PBT, float glass and stainless steel 1.4301

15.5 Integrated Clock

	Unit	Value
Maximum deviation per month (RTC)	s	30

15.6 Backup Battery

	Unit	Value
Lithium battery, type CR2032		
Service life at room temperature, minimum	Years	10

15.7 Metrological Data

15.7.1 Models MCE14202S | MCE14202P | MCE10202S | MCE8202S

		MCE14202S	MCE14202P	MCE10202S	MCE8202S
	Unit	Value	Value	Value	Value
Scale interval (d)	mg	10	10 20 50	10	10
Maximum capacity (Max)	g	14200	3500 7000 14200	10200	8200
Repeatability at 5% load					
Standard deviation of the load values, tolerance	mg	10	10	7	7
Standard deviation of the load values, typical value	mg	4	4	4	4
Repeatability at approx. maximum capacity					
Standard deviation of the load values, tolerance	mg	10	10	7	7
Standard deviation of the load values, typical value	mg	5	5	5	4
Linearity deviation					
Tolerance	mg	30	50	20	20
Typical value	mg	10	20	6	6
Deviation when load is off-center, positions according to OIML R76					
Test weight	g	5000	5000	5000	5000
Tolerance	mg	20	40	20	30
Typical value	mg	10	10	10	10
Sensitivity drift between +10°C and +30°C	ppm/K	1.5	1.5	1.5	2
Tare-maximum capacity: Less than 100% of maximum capacity					
Accuracy class according to Directive 2014/31/EU		I	I	I	II
Verification scale interval (e) according to Directive 2014/31/EU	g	0.1	0.1	0.1	0.1
Minimum load (Min) according to Directive 2014/31/EU	g	1	1	1	0.5
Minimum initial weighing according to USP (United States Pharmacopeia), Chap. 41					
Optimum minimum initial weighing	g	8.2	8.2	8.2	8.2
Typical minimum initial weighing	g	8.2	8.2	8.2	8.2
Typical stabilization time	s	0.8	0.8	0.8	1
Typical measurement time	s	1.5	1.5	1.5	1.5

15.7.2 Models MCE6202S | MCE6202P | MCE4202S | MCE2202S

		MCE6202S	MCE6202P	MCE4202S	MC2202S
	Unit	Value	Value	Value	Value
Scale interval (d)	mg	10	10 20 50	10	10
Maximum capacity (Max)	g	6200	1500 3000 6200	4200	2200
Repeatability at 5% load					
Standard deviation of the load values, tolerance	mg	7	7	7	7
Standard deviation of the load values, typical value	mg	4	4	4	4
Repeatability at approx. maximum capacity					
Standard deviation of the load values, tolerance	mg	7	40	7	7
Standard deviation of the load values, typical value	mg	4	15	4	4
Linearity deviation					
Tolerance	mg	20	50	20	20
Typical value	mg	6	20	6	6
Deviation when load is off-center, positions according to OIML R76					
Test weight	g	2000	2000	2000	1000
Tolerance	mg	20	30	30	20
Typical value	mg	10	30	10	10
Sensitivity drift between +10°C and +30°C	ppm/K	2	2	2	2
Tare-maximum capacity: Less than 100% of maximum capacity					
Accuracy class according to Directive 2014/31/EU		II	II	II	II
Verification scale interval (e) according to Directive 2014/31/EU	g	0.1	0.1	0.1	0.1
Minimum load (Min) according to Directive 2014/31/EU	g	0.5	0.5	0.5	0.5
Minimum initial weighing according to USP (United States Pharmacopeia), Chap. 41					
Optimum minimum initial weighing	g	8.2	8.2	8.2	8.2
Typical minimum initial weighing	g	8.2	8.2	8.2	8.2
Typical stabilization time	s	1	1	1	0.8
Typical measurement time	s	1.5	1.5	1	1.5

15.7.3 Models MCE1202S | MCE12201S | MCE8201S | MCE5201S

		MCE1202S	MCE12201S	MCE8201S	MC5201S
	Unit	Value	Value	Value	Value
Scale interval (d)	mg	10	100	100	100
Maximum capacity (Max)	g	1200	12200	8200	5200
Repeatability at 5% load					
Standard deviation of the load values, tolerance	mg	7	50	50	50
Standard deviation of the load values, typical value	mg	4	20	20	20
Repeatability at approx. maximum capacity					
Standard deviation of the load values, tolerance	mg	7	50	50	50
Standard deviation of the load values, typical value	mg	4	20	20	20
Linearity deviation					
Tolerance	mg	20	100	100	100
Typical value	mg	6	30	30	20
Deviation when load is off-center, positions according to OIML R76					
Test weight	g	500	5000	5000	2000
Tolerance	mg	20	200	200	200
Typical value	mg	10	100	100	100
Sensitivity drift between +10°C and +30°C	ppm/K	2	4	4	4
Tare-maximum capacity: Less than 100% of maximum capacity					
Accuracy class according to Directive 2014/31/EU		II	II	II	II
Verification scale interval (e) according to Directive 2014/31/EU	g	0.1	1	1	1
Minimum load (Min) according to Directive 2014/31/EU	g	0.5	5	5	5
Minimum initial weighing according to USP (United States Pharmacopeia), Chap. 41					
Optimum minimum initial weighing	g	8.2	82	82	82
Typical minimum initial weighing	g	8.2	82	82	82
Typical stabilization time	s	0.8	0.8	0.8	0.8
Typical measurement time	s	1	1	1	1

15.8 Recommended Calibration Weight

		MCE14202S	MCE14202P	MCE10202S	MCE8202S
	Unit	Value	Value	Value	Value
External test weight	g	14000	14000	10000	7000
Recommended accuracy class		E2	E2	E2	E2

		MCE6202S	MCE6202P	MCE4202S	MCE2202S
	Unit	Value	Value	Value	Value
External test weight	g	5000	5000	3000	1500
Recommended accuracy class		E2	E2	E2	E2

		MCE1201S	MCE12201S	MCE8201S	MCE5201S
	Unit	Value	Value	Value	Value
External test weight	g	700	12000	8000	5000
Recommended accuracy class		E2	F1	F1	F1

15.9 isoCAL Function

15.9.1 Models MCE14202S | MCE14202P | MCE10202S

	Unit	Value
isoCAL is triggered by the following criteria:		
In the event of a temperature change	K	1.5
After a time interval	h	6
After successful leveling		

15.9.2 Models MCE8202S | MCE6202S | MCE6202P | MCE4202S | MCE2202S | MCE1202S

	Unit	Value
isoCAL is triggered by the following criteria:		
In the event of a temperature change	K	2
After a time interval	h	12
After successful leveling		

15.9.3 Models MCE12201S | MCE8201S | MCE5201S

	Unit	Value
isoCAL is triggered by the following criteria:		
In the event of a temperature change	K	4
After a time interval	h	12
After successful leveling		

15.10 Interfaces

15.10.1 Specifications for the COM-RS232 Interface

Type of interface	Serial interface
Interface operation	Full duplex
Level	RS232
Connection	D-sub connector, 9-pin
Maximum cable length	10 m

Pin assignment

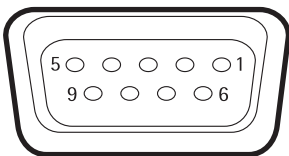

- Pin 1: **Not** assigned
- Pin 2: Data output (TxD)
- Pin 3: Data input (RxD)
- Pin 4: **Not** assigned
- Pin 5: Internal ground
- Pin 6: **Not** assigned
- Pin 7: Clear to Send (CTS)
- Pin 8: Request to Send (RTS)
- Pin 9: **Not** assigned

15.10.2 Specifications for the USB-A Interface

Communication	USB host (master)
Connectable devices	Sartorius printers, USB sticks with software update

15.10.3 Specifications for the USB-B Interface

Communication	USB device (slave)
Type of interface	Virtual serial interface (virtual COM-port, VCP) and "PC direct" communication

16 Accessories

16.1 Accessories

This table contains an excerpt of the accessories that can be ordered. For information on other products, contact Sartorius.

16.1.1 Printers and Communication

Item	Quantity	Order number
Thermal transfer thermal printer for GLP GMP printouts on continuous paper and labels	1	YDP30
Display cable, 3 m, for separate installation of display and weighing units, installation by Sartorius Service or at the factory	1	VF4754
Installation of display cable, 3 m, for separate installation of display and weighing units	1	VF4016
Cable, 3 m, between the weighing module and electronics module for semi-microbalance	1	YCC01-MSM3
RS232C connection cable, 9-pin, 3 m, for connection to a PC with 9-pin COM port	1	VF4761
Sartorius Wedge, software for data communication between the PC and balance	1	YSW02
Second display	1	YSD01

16.1.2 Displays and Input | Output Elements

Item	Quantity	Order number
MCA operating display with color TFT display, touch screen and removable palm-operated keys, for devices with automatic draft shield	1	69MS0212
MCA operating display with color TFT display and touch screen, for devices with manual draft shield	1	69MS0215
MCA operating display with color TFT display and touch screen, for high-capacity precision balances, including adapter for short distances	1	69MS0216
Motion sensor for triggering a maximum of 4 functions via gesture control, selection via menu	1	YHS02MS

16.1.3 Weighing Tables

Item	Quantity	Order number
Weighing table		
made from synthetic stone, with vibration dampening	1	YWT03
made from wood with synthetic stone	1	YWT09
Wall console	1	YWT04

16.1.4 Weighing Accessories

Item	Quantity	Order number
Weighing scoop made from chrome-nickel steel, L 90 mm × W 32 mm × H 8 mm	1	641214
Stand for weighing modules with scale intervals of 10 mg and 100 g, for raising the control unit	1	YDH03MS

17 Sartorius Service

Sartorius Service is available for queries regarding the device. For information about the service addresses, services provided, or to contact a local representative, please visit the Sartorius website (www.sartorius.com).

When contacting Sartorius Service with questions about the system or in the event of malfunctions, be sure to have the device information, e.g., serial number, hardware, firmware, configuration, close at hand. Consult the information on the manufacturer's ID label and in the "Device Information" menu (see Chapter "4.5.1 Overview of the Device Settings Menu", page 19).

18 Conformity Documents

The attached Declaration of Conformity hereby confirms compliance of the device with the directives cited.



The declaration of conformity supplied here is for conformity-assessed (verified) balances for use in the EEA. Please keep it in a safe place.

SARTORIUS



Original

EG-/EU-Konformitätserklärung EC / EU Declaration of Conformity

Hersteller **Sartorius Lab Instruments GmbH & Co. KG**
 Manufacturer 37070 Goettingen, Germany

erklärt in alleiniger Verantwortung, dass das Betriebsmittel
declares under sole responsibility that the equipment

Geräteart **Elektronische Präzisions-, Milligramm-, Analysen-, Semimikro-, Mikro-Klein- und Hochlastwaage | Netzgerät | Handsensor | Klimamodul**

Device type *Electronical Precision, Milligram, Analytical, Semi micro, Micro-Small, and High-Capacity Balance | Power Supply | Hand sensor | Climatic module*

Modell **MCAvw-2x-y, MCEvw-2x-y | YEPS03-15V0 | YHS02MS | YCM20MC, YCM20MC-DAKKS**

Model

v = 2.7, 3.6, 6.6, 10.6, 124, 125, 224, 225, 323, 324, 524, 623, 1202, 1203, 2202, 2203, 3203, 4202, 5201, 5202, 5203, 6202, 8201, 8202, 10202, 11201, 12201, 14202, 20201, 32202, 36200, 36201, 50201, 70200, 70201;

w = S, P; x = S00, S01, CEU, CFR, CCN, OBR, OIN, ORU, OJP; y = A, E, F, I, M, O, R, U

in der von uns in Verkehr gebrachten Ausführung allen einschlägigen Bestimmungen der folgenden Europäischen Richtlinien entspricht und die anwendbaren Anforderungen folgender harmonisierter Europäischer Normen einschließlich deren zum Zeitpunkt der Erklärung geltenden Änderungen erfüllt:

in the form as delivered fulfils all the relevant provisions of the following European Directives and meets the applicable requirements of the harmonized European Standards including any amendments valid at the time this declaration was signed listed below:

	EMV / EMC	RoHS	Maschinen / Machines
Richtlinie Directive	2014/30/EU	2011/65/EU	2006/42/EG 2006/42/EC
Norm(en) Standard(s)	EN 61326-1:2013	EN 50581:2012	EN ISO 12100:2010 EN 61010-1:2010 ^{*)}

Die Person, die bevollmächtigt ist, die technischen Unterlagen zusammenzustellen:
The person authorised to compile the technical file:

Sartorius Lab Instruments GmbH & Co. KG
 Electronics & Product Compliance
 37070 Goettingen, Germany

Sartorius Lab Instruments GmbH & Co.
 KG Goettingen, 2021-01-14

Dr. Reinhard Baumfalk
 Head of Product Development (LPS Division)

Halil Yildirim
 Product Compliance Officer (SLI)

*: angewandte, jedoch für Maschinen nicht harmonisierte Norm /
applied standard, which however is not harmonized for machines

Doc: 2369814-03 SLI18CE001-03.de,en 1/1 PMF: 2369813 OP-113_fo1_2020.07.07



Original

SARTORIUS

UK Declaration of Conformity

Manufacturer Sartorius Lab Instruments GmbH & Co. KG
37070 Goettingen, Germany

declares under sole responsibility that the equipment

Device type Electronical Precision, Milligram, Analytical, Semi micro, Micro-Small and High-Capacity Balance | Power Supply | Hand sensor | Climatic module

Type series CUBIS

Model MCAvw-2x-y, MCEvw-2x-y | YEPS03-15V0 | YHS02MS | YCM20MC, YCM20MC-DAKKS

v = 2.7, 3.6, 6.6, 10.6, 124, 125, 224, 225, 323, 324, 524, 623, 1202, 1203, 2202, 2203, 3203, 4202, 5201, 5202, 5203, 6202, 8201, 8202, 10202, 11201, 12201, 14202, 20201, 32202, 36200, 36201, 50201, 70200, 70201;

w = S, P; x = S00, S01, CEU, CFR, CCN, OBR, OIN, ORU, OJP; y = A, E, F, I, M, O, R, U

in the form as delivered fulfils all the relevant provisions of the following British Regulations and meets the applicable requirements of the British Designated Standards including any amendments valid at the time this declaration was signed listed below:

The Electromagnetic Compatibility Regulations 2016

UK Statutory Instruments 2016 No. 1091

BS EN 61326-1:2013

The Restriction of the Use of Certain Hazardous Substances in Electrical and Electronic Equipment Regulations 2012; UK Statutory Instruments 2012 No. 3032

BS EN 50581:2012

The Supply of Machinery (Safety) Regulations 2008

UK Statutory Instruments 2008 No. 1597

BS EN ISO 12100:2010, BS EN 61010-1:2010^{*})

The person authorised to compile the technical file:

Sartorius UK Ltd.

Longmead Business Centre, Blenheim Road

KT19 9 QQ Epsom, Surrey, UK

Sartorius Lab Instruments GmbH & Co. KG

Goettingen, 2021-04-28

Dr. Reinhard Baumfalk
Head of Product Development (LPS)

Halil Yildirim
Product Compliance Officer (SLI)

*: applied standard, which however is not harmonized for machines

Sartorius Lab Instruments GmbH & Co. KG
Otto-Brenner-Strasse 20
37079 Goettingen, Germany

Phone: +49 551 308 0
www.sartorius.com

The information and figures contained in these instructions correspond to the version date specified below.

Sartorius reserves the right to make changes to the technology, features, specifications and design of the equipment without notice.

Masculine or feminine forms are used to facilitate legibility in these instructions and always simultaneously denote the other gender as well.

Copyright notice:

This instruction manual, including all of its components, is protected by copyright. Any use beyond the limits of the copyright law is not permitted without our approval.

This applies in particular to reprinting, translation and editing irrespective of the type of media used.

© Sartorius Germany

Last updated:

07 | 2021